



DOMOTICS

PRODUCT CATALOGUE

GEWISS



2018
2019



GEWISS is an international leader in the production of systems and components for low voltage electrical installations. The fact that development is seen as a constant management feature has permitted GEWISS to assert itself as a reference interlocutor for the electrotechnical market in the creation of solutions for domotics, energy and the lighting industry. It is now present in Italy, France, Germany, the United Kingdom, Spain, Portugal, China, Russia, Turkey, Romania, Chile, the United Arab Emirates, and in a further 80 countries around the world.

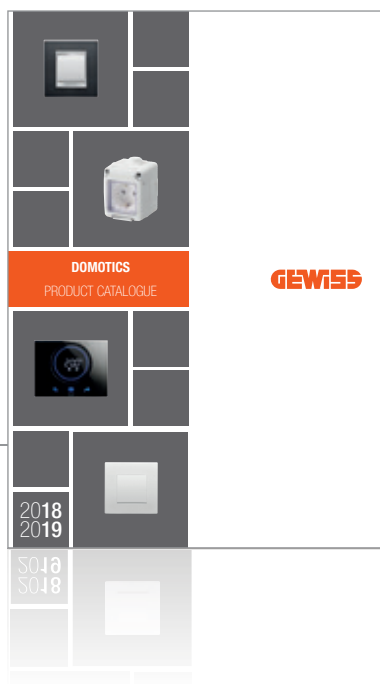

DOMOTICS

The domotic systems offer cutting-edge solutions for smart home and building management and control, guaranteeing safety, comfort and energy savings along with Italian design.



POWER

The technologically advanced range of modular and moulded-case devices joins the vast range of distribution boards and cabinets, enclosures and combined boards to create the GEWISS Protection System.



BUILDING

Junction boxes and special containers, a complete and coordinated line of distribution boards, cutting-edge industrial connections and an integrated system of boards for special systems create the GEWISS distribution systems.



LIGHTING

Lighting systems designed for every room, area and location. Solutions that embrace LED technology to meet the requirements of industrial and commercial sector contexts, sport facilities and emergency lighting.

Discover the complete offer

www.gewiss.com

Residential solutions and domotic systems

GEWISS provides ground-breaking solutions for smart home and building management and is able to meet any need. The wide range of products includes wiring devices systems in compliance with all the major international standards and a Home&Building Automation system based on various technologies (wireless and KNX bus), which is able to improve the building/system performances in terms of energy savings, comfort and safety. The system functions, in particular, are supervised both locally and from a distance, via the internet. Each component has been developed with shapes, lines and materials offering a wealth of design solutions to suit every application context.

Chorus



page 6

Chorus British Standard



page 36

System



page 42

27 Combi



page 53

Dahlia



page 56

Wireless Devices



page 64

Home Automation

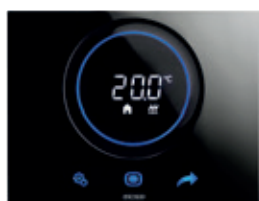

page 66

Building Automation



page 70

Domo Center



page 78

Domestic ranges

Chorus

PLATES AND MODULAR DEVICES



pag. 6

Chorus British Standard

PLATES AND DEVICES



pag. 36

System

PLATES AND MODULAR DEVICES



pag. 42

27 Combi

WALL-MOUNTING ENCLOSURES
AND MODULAR COMPONENTS



pag. 53

Dahlia

PLATES AND DEVICES



pag. 56

International system

CHORUS is the innovative wiring devices system of Gewiss which is based on a wide range of modular devices, expandable and integrable thanks to the Gewiss wireless and Home&Building Automation solutions. The CHORUS range has been designed to be marketed and installed in all the most important countries of the world. This choice is the result of 30 years' experience in domestic ranges, and expresses the company's vision that resolutely opens up to the global market.



Chorus International plates

ONE INTERNATIONAL, GEO INTERNATIONAL and LUX INTERNATIONAL plates from the Chorus wiring devices system, made in technopolymer or in precious materials and available in a wide range of colors and finishes, are suitable for round and square boxes and use the same support frame without the need for additional adapters.

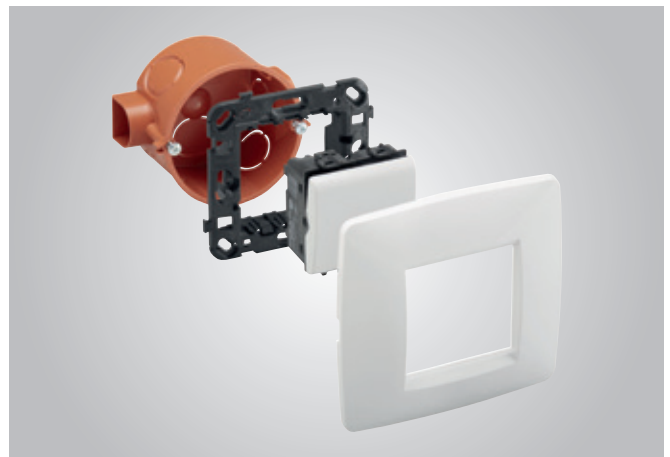

Flexibility and modularity of frame supports

The frame supports for the Chorus International plates, made in technopolymer and provided with sturdy ribs that ensure high stability during the installation steps, are available for the fixing both with clutches or screws.

The long slots positioned along the sides also allow an easy coupling with square/round boxes provided with fixing columns. The frame supports for the International plates are fitted with side couplings to ensure perfect alignment when using 2+2 gang, 2+2+2 gang and 2+2+2+2 gang plates (both horizontal and vertical configuration, and centre distances of 71 and 57mm).

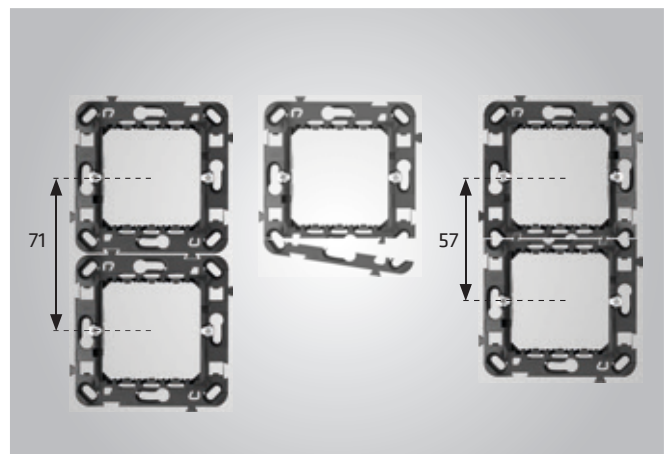

The design that lights up every environment. **The CHORUS plates** embellish every environment with the elegance of their unique design and with the durability and refinement of state-of-the-art materials.

Classic and informal

With an informal appearance and classic geometries, ONE INTERNATIONAL is the line of plates that is dedicated to everyone who wants to furnish their home with forms of simplicity.

The 100% technopolymer ONE INTERNATIONAL plates are available in classic, painted, metallised and pastel colours with fabric effect. The plates, suitable for round and square flush-mounting boxes, offer horizontal and vertical solutions with a centre distance of 57 and 71mm.



Pure simplicity

GEO INTERNATIONAL, with essential and regular lines, can be perfectly inserted in any environment with simplicity and style. The 100% technopolymer GEO INTERNATIONAL plates are available in classic, painted, metallised and pastel colours with fabric effect. The plates, suitable for round and square flush-mounting boxes, offer horizontal and vertical solutions with a centre distance of 71mm.



Refined design

Thanks to a highly innovative shape in terms of both materials and colours, interior design is enriched with a sophisticated look. The LUX INTERNATIONAL plates, made in technopolymer (also in wood finish, leather finish and stone finish) or in precious materials (metal and glass), are suitable for round and square flush-mounting boxes and offer horizontal and vertical solutions with a centre distance of 57 and 71mm.



ONE INTERNATIONAL PLATES

Technopolymer

MILK WHITE



GW 16 122 TB	2 gang
GW 16 123 TB	2+2 horiz. gang
GW 16 124 TB	2+2 vert. gang
GW 16 125 TB	2+2 vert. gang 57mm
GW 16 126 TB	2+2+2 horiz. gang
GW 16 127 TB	2+2+2 vert. gang
GW 16 128 TB	2+2+2+2 horiz. gang
GW 16 129 TB	2+2+2+2 vert. gang

IVORY



GW 16 122 TI	2 gang
GW 16 123 TI	2+2 horiz. gang
GW 16 124 TI	2+2 vert. gang
GW 16 126 TI	2+2+2 horiz. gang
GW 16 127 TI	2+2+2 vert. gang
GW 16 128 TI	2+2+2+2 horiz. gang
GW 16 129 TI	2+2+2+2 vert. gang

TITANIUM



GW 16 122 VT	2 gang
GW 16 123 VT	2+2 horiz. gang
GW 16 124 VT	2+2 vert. gang
GW 16 126 VT	2+2+2 horiz. gang
GW 16 127 VT	2+2+2 vert. gang
GW 16 128 VT	2+2+2+2 horiz. gang
GW 16 129 VT	2+2+2+2 vert. gang

TONER BLACK



GW 16 122 TN	2 gang
GW 16 123 TN	2+2 horiz. gang
GW 16 124 TN	2+2 vert. gang
GW 16 126 TN	2+2+2 horiz. gang
GW 16 127 TN	2+2+2 vert. gang
GW 16 128 TN	2+2+2+2 horiz. gang
GW 16 129 TN	2+2+2+2 vert. gang

HEMP



GW 16 122 TC	2 gang
GW 16 123 TC	2+2 horiz. gang
GW 16 124 TC	2+2 vert. gang
GW 16 126 TC	2+2+2 horiz. gang
GW 16 127 TC	2+2+2 vert. gang
GW 16 128 TC	2+2+2+2 horiz. gang
GW 16 129 TC	2+2+2+2 vert. gang

SLATE



GW 16 122 VA	2 gang
GW 16 123 VA	2+2 horiz. gang
GW 16 124 VA	2+2 vert. gang
GW 16 126 VA	2+2+2 horiz. gang
GW 16 127 VA	2+2+2 vert. gang
GW 16 128 VA	2+2+2+2 horiz. gang
GW 16 129 VA	2+2+2+2 vert. gang

Metallised technopolymer

CHROME



GW 16 122 MC	2 gang
GW 16 123 MC	2+2 horiz. gang
GW 16 124 MC	2+2 vert. gang
GW 16 126 MC	2+2+2 horiz. gang
GW 16 127 MC	2+2+2 vert. gang
GW 16 128 MC	2+2+2+2 horiz. gang
GW 16 129 MC	2+2+2+2 vert. gang

GOLD



GW 16 122 MO	2 gang
GW 16 123 MO	2+2 horiz. gang
GW 16 124 MO	2+2 vert. gang
GW 16 126 MO	2+2+2 horiz. gang
GW 16 127 MO	2+2+2 vert. gang
GW 16 128 MO	2+2+2+2 horiz. gang
GW 16 129 MO	2+2+2+2 vert. gang

Painted technopolymer - Pastel colours

RUBY



GW 16 122 VR	2 gang
GW 16 123 VR	2+2 horiz. gang
GW 16 124 VR	2+2 vert. gang
GW 16 126 VR	2+2+2 horiz. gang
GW 16 127 VR	2+2+2 vert. gang
GW 16 128 VR	2+2+2+2 horiz. gang
GW 16 129 VR	2+2+2+2 vert. gang

SEA BLUE



GW 16 122 VB	2 gang
GW 16 123 VB	2+2 horiz. gang
GW 16 124 VB	2+2 vert. gang
GW 16 126 VB	2+2+2 horiz. gang
GW 16 127 VB	2+2+2 vert. gang
GW 16 128 VB	2+2+2+2 horiz. gang
GW 16 129 VB	2+2+2+2 vert. gang

Painted technopolymer

Modularity

Centre distance 71 mm

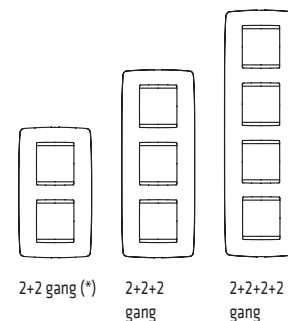
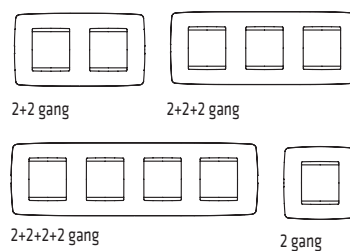

(*) Available also with centre distance 57 mm (only milk white).

GEO INTERNATIONAL PLATES

Technopolymer

MILK WHITE



GW 16 422 TB	2 gang
GW 16 423 TB	2+2 horiz. gang
GW 16 424 TB	2+2 vert. gang
GW 16 426 TB	2+2+2 horiz. gang
GW 16 427 TB	2+2+2 vert. gang

IVORY



GW 16 422 TI	2 gang
GW 16 423 TI	2+2 horiz. gang
GW 16 424 TI	2+2 vert. gang
GW 16 426 TI	2+2+2 horiz. gang
GW 16 427 TI	2+2+2 vert. gang

TITANIUM



GW 16 422 VT	2 gang
GW 16 423 VT	2+2 horiz. gang
GW 16 424 VT	2+2 vert. gang
GW 16 426 VT	2+2+2 horiz. gang
GW 16 427 VT	2+2+2 vert. gang

TONER BLACK



GW 16 422 TN	2 gang
GW 16 423 TN	2+2 horiz. gang
GW 16 424 TN	2+2 vert. gang
GW 16 426 TN	2+2+2 horiz. gang
GW 16 427 TN	2+2+2 vert. gang

HEMP



GW 16 422 TC	2 gang
GW 16 423 TC	2+2 horiz. gang
GW 16 424 TC	2+2 vert. gang
GW 16 426 TC	2+2+2 horiz. gang
GW 16 427 TC	2+2+2 vert. gang

SLATE



GW 16 422 VA	2 gang
GW 16 423 VA	2+2 horiz. gang
GW 16 424 VA	2+2 vert. gang
GW 16 426 VA	2+2+2 horiz. gang
GW 16 427 VA	2+2+2 vert. gang

Painted technopolymer

Metallised technopolymer

CHROME



GW 16 422 MC	2 gang
GW 16 423 MC	2+2 horiz. gang
GW 16 424 MC	2+2 vert. gang
GW 16 426 MC	2+2+2 horiz. gang
GW 16 427 MC	2+2+2 vert. gang

GOLD



GW 16 422 MO	2 gang
GW 16 423 MO	2+2 horiz. gang
GW 16 424 MO	2+2 vert. gang
GW 16 426 MO	2+2+2 horiz. gang
GW 16 427 MO	2+2+2 vert. gang

RUBY



GW 16 422 VR	2 gang
GW 16 423 VR	2+2 horiz. gang
GW 16 424 VR	2+2 vert. gang
GW 16 426 VR	2+2+2 horiz. gang
GW 16 427 VR	2+2+2 vert. gang

SEA BLUE



GW 16 422 VB	2 gang
GW 16 423 VB	2+2 horiz. gang
GW 16 424 VB	2+2 vert. gang
GW 16 426 VB	2+2+2 horiz. gang
GW 16 427 VB	2+2+2 vert. gang

Painted technopolymer - Pastel colours

Modularity

Centre distance 71 mm

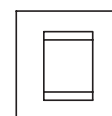

2 gang

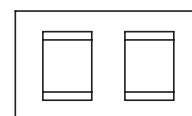

2+2 gang

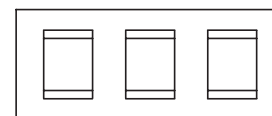

2+2+2 gang

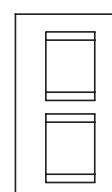

2+2 gang

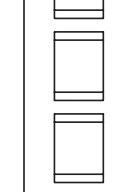

2+2+2 gang

LUX INTERNATIONAL PLATES

Technopolymer

MILK WHITE



MONOCHROME

GW 16 222 TB	2 gang	GW 16 222 YB
GW 16 223 TB	2+2 horiz. gang	GW 16 223 YB
GW 16 224 TB	2+2 vert. gang	GW 16 224 YB
GW 16 225 TB	2+2 vert. gang 57mm	
GW 16 226 TB	2+2+2 horiz. gang	GW 16 226 YB
GW 16 227 TB	2+2+2 vert. gang	GW 16 227 YB
GW 16 228 TB	2+2+2+2 horiz. gang	GW 16 228 YB
GW 16 229 TB	2+2+2+2 vert. gang	GW 16 229 YB

TONER BLACK



GW 16 222 TN	2 gang
GW 16 223 TN	2+2 horiz. gang
GW 16 224 TN	2+2 vert. gang
GW 16 226 TN	2+2+2 horiz. gang
GW 16 227 TN	2+2+2 vert. gang
GW 16 228 TN	2+2+2+2 horiz. gang
GW 16 229 TN	2+2+2+2 vert. gang

Painted technopolymer

TITANIUM



GW 16 222 VT	2 gang
GW 16 223 VT	2+2 horiz. gang
GW 16 224 VT	2+2 vert. gang
GW 16 226 VT	2+2+2 horiz. gang
GW 16 227 VT	2+2+2 vert. gang
GW 16 228 VT	2+2+2+2 horiz. gang
GW 16 229 VT	2+2+2+2 vert. gang

SLATE



GW 16 222 VA	2 gang
GW 16 223 VA	2+2 horiz. gang
GW 16 224 VA	2+2 vert. gang
GW 16 226 VA	2+2+2 horiz. gang
GW 16 227 VA	2+2+2 vert. gang
GW 16 228 VA	2+2+2+2 horiz. gang
GW 16 229 VA	2+2+2+2 vert. gang

Metallised technopolymer

CHROME



GW 16 222 MC	2 gang
GW 16 223 MC	2+2 horiz. gang
GW 16 224 MC	2+2 vert. gang
GW 16 226 MC	2+2+2 horiz. gang
GW 16 227 MC	2+2+2 vert. gang
GW 16 228 MC	2+2+2+2 horiz. gang
GW 16 229 MC	2+2+2+2 vert. gang

GOLD



GW 16 222 MO	2 gang
GW 16 223 MO	2+2 horiz. gang
GW 16 224 MO	2+2 vert. gang
GW 16 226 MO	2+2+2 horiz. gang
GW 16 227 MO	2+2+2 vert. gang
GW 16 228 MO	2+2+2+2 horiz. gang
GW 16 229 MO	2+2+2+2 vert. gang

Technopolymer - Wood finish

MAPLE



GW 16 222 LA	2 gang
GW 16 223 LA	2+2 horiz. gang
GW 16 224 LA	2+2 vert. gang
GW 16 226 LA	2+2+2 horiz. gang
GW 16 227 LA	2+2+2 vert. gang
GW 16 228 LA	2+2+2+2 horiz. gang
GW 16 229 LA	2+2+2+2 vert. gang

WENGE



GW 16 222 LW	2 gang
GW 16 223 LW	2+2 horiz. gang
GW 16 224 LW	2+2 vert. gang
GW 16 226 LW	2+2+2 horiz. gang
GW 16 227 LW	2+2+2 vert. gang
GW 16 228 LW	2+2+2+2 horiz. gang
GW 16 229 LW	2+2+2+2 vert. gang

CHERRY



GW 16 222 LC	2 gang
GW 16 223 LC	2+2 horiz. gang
GW 16 224 LC	2+2 vert. gang
GW 16 226 LC	2+2+2 horiz. gang
GW 16 227 LC	2+2+2 vert. gang
GW 16 228 LC	2+2+2+2 horiz. gang
GW 16 229 LC	2+2+2+2 vert. gang

Technopolymer - Leather finish

BLACK



GW 16 222 PN	2 gang
GW 16 223 PN	2+2 horiz. gang
GW 16 224 PN	2+2 vert. gang
GW 16 226 PN	2+2+2 horiz. gang
GW 16 227 PN	2+2+2 vert. gang
GW 16 228 PN	2+2+2+2 horiz. gang
GW 16 229 PN	2+2+2+2 vert. gang

WHITE



GW 16 222 PB	2 gang
GW 16 223 PB	2+2 horiz. gang
GW 16 224 PB	2+2 vert. gang
GW 16 226 PB	2+2+2 horiz. gang
GW 16 227 PB	2+2+2 vert. gang
GW 16 228 PB	2+2+2+2 horiz. gang
GW 16 229 PB	2+2+2+2 vert. gang

RUBY



GW 16 222 PR	2 gang
GW 16 223 PR	2+2 horiz. gang
GW 16 224 PR	2+2 vert. gang
GW 16 226 PR	2+2+2 horiz. gang
GW 16 227 PR	2+2+2 vert. gang
GW 16 228 PR	2+2+2+2 horiz. gang
GW 16 229 PR	2+2+2+2 vert. gang

LUX INTERNATIONAL PLATES

Technopolymer - Stone finish

LAVA



GW 16 222 RL	2 gang
GW 16 223 RL	2+2 horiz. gang
GW 16 224 RL	2+2 vert. gang
GW 16 226 RL	2+2+2 horiz. gang
GW 16 227 RL	2+2+2 vert. gang
GW 16 228 RL	2+2+2+2 horiz. gang
GW 16 229 RL	2+2+2+2 vert. gang

SAND



GW 16 222 RS	2 gang
GW 16 223 RS	2+2 horiz. gang
GW 16 224 RS	2+2 vert. gang
GW 16 226 RS	2+2+2 horiz. gang
GW 16 227 RS	2+2+2 vert. gang
GW 16 228 RS	2+2+2+2 horiz. gang
GW 16 229 RS	2+2+2+2 vert. gang

MOON



GW 16 222 RN	2 gang
GW 16 223 RN	2+2 horiz. gang
GW 16 224 RN	2+2 vert. gang
GW 16 226 RN	2+2+2 horiz. gang
GW 16 227 RN	2+2+2 vert. gang
GW 16 228 RN	2+2+2+2 horiz. gang
GW 16 229 RN	2+2+2+2 vert. gang

Metal

BRUSHED
STAINLESS STEEL



GW 16 222 MI	2 gang
GW 16 223 MI	2+2 horiz. gang
GW 16 224 MI	2+2 vert. gang
GW 16 226 MI	2+2+2 horiz. gang
GW 16 227 MI	2+2+2 vert. gang
GW 16 228 MI	2+2+2+2 horiz. gang
GW 16 229 MI	2+2+2+2 vert. gang

BLACK ALUMINIUM



GW 16 222 MA	2 gang
GW 16 223 MA	2+2 horiz. gang
GW 16 224 MA	2+2 vert. gang
GW 16 226 MA	2+2+2 horiz. gang
GW 16 227 MA	2+2+2 vert. gang
GW 16 228 MA	2+2+2+2 horiz. gang
GW 16 229 MA	2+2+2+2 vert. gang

OXIDISED FINISH



GW 16 222 MF	2 gang
GW 16 223 MF	2+2 horiz. gang
GW 16 224 MF	2+2 vert. gang
GW 16 226 MF	2+2+2 horiz. gang
GW 16 227 MF	2+2+2 vert. gang
GW 16 228 MF	2+2+2+2 horiz. gang
GW 16 229 MF	2+2+2+2 vert. gang

Glass

ICE



GW 16 222 CG	2 gang
GW 16 223 CG	2+2 horiz. gang
GW 16 224 CG	2+2 vert. gang
GW 16 226 CG	2+2+2 horiz. gang
GW 16 227 CG	2+2+2 vert. gang
GW 16 228 CG	2+2+2+2 horiz. gang
GW 16 229 CG	2+2+2+2 vert. gang

AQUAMARINE



GW 16 222 CA	2 gang
GW 16 223 CA	2+2 horiz. gang
GW 16 224 CA	2+2 vert. gang
GW 16 226 CA	2+2+2 horiz. gang
GW 16 227 CA	2+2+2 vert. gang
GW 16 228 CA	2+2+2+2 horiz. gang
GW 16 229 CA	2+2+2+2 vert. gang

OCHRE



GW 16 222 CO	2 gang
GW 16 223 CO	2+2 horiz. gang
GW 16 224 CO	2+2 vert. gang
GW 16 226 CO	2+2+2 horiz. gang
GW 16 227 CO	2+2+2 vert. gang
GW 16 228 CO	2+2+2+2 horiz. gang
GW 16 229 CO	2+2+2+2 vert. gang



(*) Available also with centre distance 57 mm (only milk white)

Chorus Italian standard plates

ONE and GEO plates, with their classic shapes and LUX, ART, ICE and ICE touch plates, refined and exclusive, are suitable for rectangular boxes and use the same support frame without the need for additional adapters.

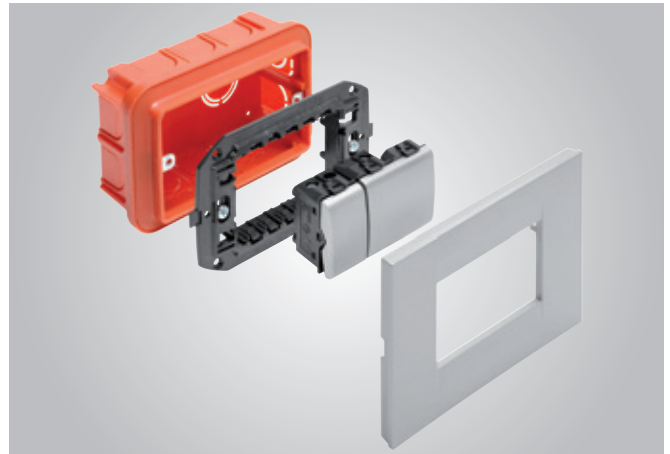

Flexibility of frame supports

The frame supports for the Chorus Italian standard plates, made in technopolymer and provided with sturdy ribs that ensure high stability during the installation steps, are fixed to the boxes by means of screws. The long slots positioned along the sides also allow an easy coupling with flush- or wall-mounting rectangular boxes.

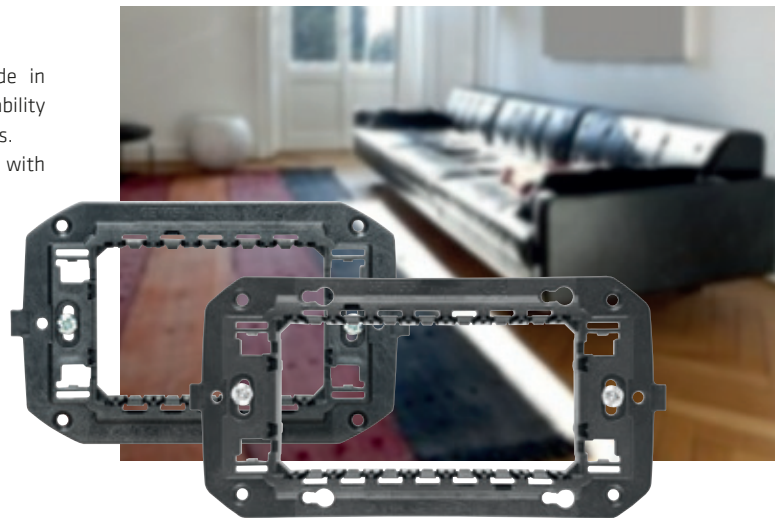

The light and rational design

ONE plates are characterised by a classic and traditional shape, outstanding for their discretion and essentiality. They offer a highly modular range that solves the most varied installation needs. The style of the GEO plates was created to satisfy the needs of contemporary design. The rationality of the rectangular shape is enhanced by the lightness and simplicity of the surface that frames the command buttons. The 100% technopolymer plates are available in classic, painted, metallised and pastel colours with fabric effect.



The refined and creative design

The ART plates present a futuristic design and innovative materials. An extremely original and creative line of plates, with an oval form, which in itself can furnish and decorate every room. The LUX plates, elegant and original, with their chromed or monochrome inner frame and soft curves emphasising the clean, pure shapes. Exclusive and refined, they are in harmony with their surrounds thanks to the geometry and fine materials (technopolymer, technostone, wood, leather, glass and metal).



Art and Lux

The extraordinary design

The ICE plates combine the pure luxury of glass with the sleek sophistication of conventional controls. Available in white, black and titanium, can be used with all Chorus range modular devices, including commands, systems for power take-off, protection and signalling, comfort, climate control and technical alarms. ICE can deliver solutions for all situations.



Ice

Touch command

With ICE Touch - the glass plates in black, white and titanium with elegant illuminable symbols - finish quality and colour uniformity become the distinctive element of each Chorus lighting device. Touch technology, in combination with the ICE plates, becomes universally available, making it possible to implement both traditional and domotic touch commands.



Ice Touch

ONE PLATES

MILK WHITE



GW 16 101 TB	1 gang
GW 16 102 TB	2 gang
GW 16 103 TB	3 gang
GW 16 104 TB	4 gang
GW 16 106 TB	6 gang
GW 16 108 TB	4+4 gang
GW 16 112 TB	6+6 gang

IVORY



GW 16 101 TI	1 gang
GW 16 102 TI	2 gang
GW 16 103 TI	3 gang
GW 16 104 TI	4 gang
GW 16 106 TI	6 gang

TONER BLACK



GW 16 101 TN	1 gang
GW 16 102 TN	2 gang
GW 16 103 TN	3 gang
GW 16 104 TN	4 gang
GW 16 106 TN	6 gang

HEMP



GW 16 101 TC	1 gang
GW 16 102 TC	2 gang
GW 16 103 TC	3 gang
GW 16 104 TC	4 gang
GW 16 106 TC	6 gang

OPAL ORANGE



GW 16 103 TO	3 gang
GW 16 104 TO	4 gang

SAPPHIRE PINK



GW 16 103 TZ	3 gang
GW 16 104 TZ	4 gang

AMETHYST PURPLE



GW 16 103 TA	3 gang
GW 16 104 TA	4 gang

CARIBBEAN BLUE



GW 16 103 TL	3 gang
GW 16 104 TL	4 gang

TOPAZ BLUE



GW 16 103 TT	3 gang
GW 16 104 TT	4 gang

ONE PLATES

Painted technopolymer

SATIN BLACK



- GW 16 103 VN 3 gang
- GW 16 104 VN 4 gang
- GW 16 106 VN 6 gang

TITANIUM



- GW 16 101 VT 1 gang
- GW 16 102 VT 2 gang
- GW 16 103 VT 3 gang
- GW 16 104 VT 4 gang
- GW 16 106 VT 6 gang
- GW 16 108 VT 4+4 gang
- GW 16 112 VT 6+6 gang

SLATE



- GW 16 101 VA 1 gang
- GW 16 102 VA 2 gang
- GW 16 103 VA 3 gang
- GW 16 104 VA 4 gang
- GW 16 106 VA 6 gang

Metallised technopolymer

CHROME



- GW 16 101 MC 1 gang
- GW 16 102 MC 2 gang
- GW 16 103 MC 3 gang
- GW 16 104 MC 4 gang
- GW 16 106 MC 6 gang

GOLD



- GW 16 101 MO 1 gang
- GW 16 102 MO 2 gang
- GW 16 103 MO 3 gang
- GW 16 104 MO 4 gang
- GW 16 106 MO 6 gang

Painted technopolymer - Pastel colours

RUBY



- GW 16 101 VR 1 gang
- GW 16 102 VR 2 gang
- GW 16 103 VR 3 gang
- GW 16 104 VR 4 gang
- GW 16 106 VR 6 gang

SEA BLUE



- GW 16 101 VB 1 gang
- GW 16 102 VB 2 gang
- GW 16 103 VB 3 gang
- GW 16 104 VB 4 gang
- GW 16 106 VB 6 gang

Modularity

(*) Milk White and Titanium

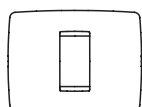

1 gang

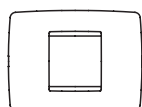

2 gang

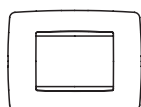

3 gang

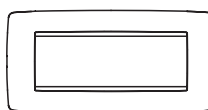

6 gang

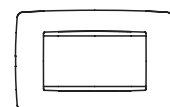

4 gang

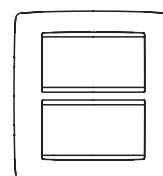

4 + 4 gang (*)

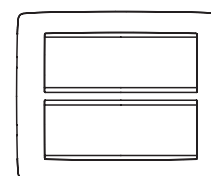

6 + 6 gang (*)

GEO PLATES

Technopolymer

MILK WHITE



GW 16 401 TB	1 gang
GW 16 402 TB	2 gang
GW 16 403 TB	3 gang
GW 16 404 TB	4 gang
GW 16 406 TB	6 gang

IVORY



GW 16 401 TI	1 gang
GW 16 402 TI	2 gang
GW 16 403 TI	3 gang
GW 16 404 TI	4 gang
GW 16 406 TI	6 gang

TONER BLACK



GW 16 401 TN	1 gang
GW 16 402 TN	2 gang
GW 16 403 TN	3 gang
GW 16 404 TN	4 gang
GW 16 406 TN	6 gang

HEMP



GW 16 401 TC	1 gang
GW 16 402 TC	2 gang
GW 16 403 TC	3 gang
GW 16 404 TC	4 gang
GW 16 406 TC	6 gang

OPAL ORANGE



GW 16 403 TO	3 gang
GW 16 404 TO	4 gang

SAPPHIRE PINK



GW 16 403 TZ	3 gang
GW 16 404 TZ	4 gang

AMETHYST PURPLE



GW 16 403 TA	3 gang
GW 16 404 TA	4 gang

CARIBBEAN BLUE



GW 16 403 TL	3 gang
GW 16 404 TL	4 gang

TOPAZ BLUE



GW 16 403 TT	3 gang
GW 16 404 TT	4 gang

GEO PLATES

Painted technopolymer

SATIN BLACK



GW 16 403 VN	3 gang
GW 16 404 VN	4 gang
GW 16 406 VN	6 gang

TITANIUM



GW 16 401 VT	1 gang
GW 16 402 VT	2 gang
GW 16 403 VT	3 gang
GW 16 404 VT	4 gang
GW 16 406 VT	6 gang

SLATE



GW 16 401 VA	1 gang
GW 16 402 VA	2 gang
GW 16 403 VA	3 gang
GW 16 404 VA	4 gang
GW 16 406 VA	6 gang

Metallised technopolymer

CHROME



GW 16 401 MC	1 gang
GW 16 402 MC	2 gang
GW 16 403 MC	3 gang
GW 16 404 MC	4 gang
GW 16 406 MC	6 gang

GOLD



GW 16 401 MO	1 gang
GW 16 402 MO	2 gang
GW 16 403 MO	3 gang
GW 16 404 MO	4 gang
GW 16 406 MO	6 gang

Painted technopolymer - Pastel colours

RUBY



GW 16 401 VR	1 gang
GW 16 402 VR	2 gang
GW 16 403 VR	3 gang
GW 16 404 VR	4 gang
GW 16 406 VR	6 gang

SEA BLUE



GW 16 401 VB	1 gang
GW 16 402 VB	2 gang
GW 16 403 VB	3 gang
GW 16 404 VB	4 gang
GW 16 406 VB	6 gang

Modularity

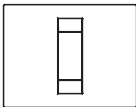

1 gang

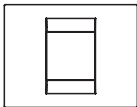

2 gang

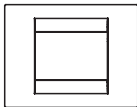

3 gang

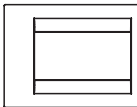

4 gang

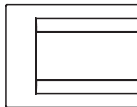

6 gang

Chorus PLATES AND MODULAR DEVICES

LUX PLATES

	Painted technopolymer		Metallised technopolymer		
Technopolymer	MILK WHITE  GW 16 202 TB 2 gang GW 16 203 TB 3 gang GW 16 204 TB 4 gang GW 16 206 TB 6 gang		TITANIUM  GW 16 202 VT 2 gang GW 16 203 VT 3 gang GW 16 204 VT 4 gang GW 16 206 VT 6 gang		
	TONER BLACK  GW 16 202 TN 2 gang GW 16 203 TN 3 gang GW 16 204 TN 4 gang GW 16 206 TN 6 gang		SLATE  GW 16 202 VA 2 gang GW 16 203 VA 3 gang GW 16 204 VA 4 gang GW 16 206 VA 6 gang		
			CHROME  GW 16 202 MC 2 gang GW 16 203 MC 3 gang GW 16 204 MC 4 gang GW 16 206 MC 6 gang		
			GOLD  GW 16 202 MO 2 gang GW 16 203 MO 3 gang GW 16 204 MO 4 gang GW 16 206 MO 6 gang		
	Wood	MAPLE  GW 16 202 LA 2 gang GW 16 203 LA 3 gang GW 16 204 LA 4 gang GW 16 206 LA 6 gang		WENGE  GW 16 202 LW 2 gang GW 16 203 LW 3 gang GW 16 204 LW 4 gang GW 16 206 LW 6 gang	
				CHERRY  GW 16 202 LC 2 gang GW 16 203 LC 3 gang GW 16 204 LC 4 gang GW 16 206 LC 6 gang	
Leather		BLACK  GW 16 202 PN 2 gang GW 16 203 PN 3 gang GW 16 204 PN 4 gang GW 16 206 PN 6 gang		WHITE  GW 16 202 PB 2 gang GW 16 203 PB 3 gang GW 16 204 PB 4 gang GW 16 206 PB 6 gang	
			RUBY  GW 16 202 PR 2 gang GW 16 203 PR 3 gang GW 16 204 PR 4 gang GW 16 206 PR 6 gang		
	Glass	ICE  GW 16 202 CG 2 gang GW 16 203 CG 3 gang GW 16 204 CG 4 gang GW 16 206 CG 6 gang		AQUAMARINE  GW 16 202 CA 2 gang GW 16 203 CA 3 gang GW 16 204 CA 4 gang GW 16 206 CA 6 gang	
		OCHRE  GW 16 202 CO 2 gang GW 16 203 CO 3 gang GW 16 204 CO 4 gang GW 16 206 CO 6 gang			

LUX PLATES



GLAMOUR RED



- GW 16 202 MR 2 gang
- GW 16 203 MR 3 gang
- GW 16 204 MR 4 gang
- GW 16 206 MR 6 gang

BRUSHED ALUMINIUM



- GW 16 202 MS 2 gang
- GW 16 203 MS 3 gang
- GW 16 204 MS 4 gang
- GW 16 206 MS 6 gang

GUNBARREL GREY



- GW 16 202 ML 2 gang
- GW 16 203 ML 3 gang
- GW 16 204 ML 4 gang
- GW 16 206 ML 6 gang

CHIC BLUE



- GW 16 202 MH 2 gang
- GW 16 203 MH 3 gang
- GW 16 204 MH 4 gang
- GW 16 206 MH 6 gang

PEARLY BRONZE



- GW 16 202 MP 2 gang
- GW 16 203 MP 3 gang
- GW 16 204 MP 4 gang
- GW 16 206 MP 6 gang

OXIDISED FINISH



- GW 16 202 MD 2 gang
- GW 16 203 MD 3 gang
- GW 16 204 MD 4 gang
- GW 16 206 MD 6 gang



WHITE



- GW 16 202 XB 2 gang
- GW 16 203 XB 3 gang
- GW 16 204 XB 4 gang
- GW 16 206 XB 6 gang

BLACK



- GW 16 202 XN 2 gang
- GW 16 203 XN 3 gang
- GW 16 204 XN 4 gang
- GW 16 206 XN 6 gang

BRUSHED STAINLESS STEEL



- GW 16 202 MI 2 gang
- GW 16 203 MI 3 gang
- GW 16 204 MI 4 gang
- GW 16 206 MI 6 gang

ALUMINIUM



- GW 16 202 XA 2 gang
- GW 16 203 XA 3 gang
- GW 16 204 XA 4 gang
- GW 16 206 XA 6 gang





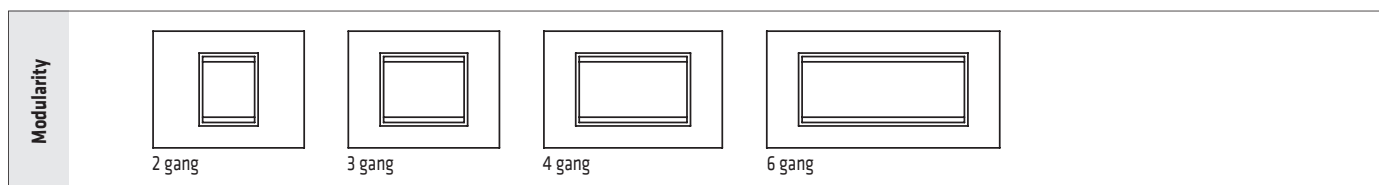

TITANIUM



- GW 16 202 XT 2 gang
- GW 16 203 XT 3 gang
- GW 16 204 XT 4 gang
- GW 16 206 XT 6 gang



ART PLATES

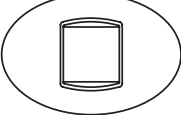
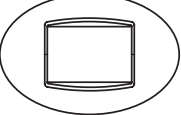
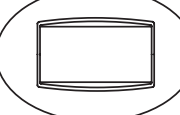

Technopolymer	MILK WHITE	TITANIUM	CHROME																		
																					
	<table border="0"> <tr><td>GW 16 302 TB</td><td>2 gang</td></tr> <tr><td>GW 16 303 TB</td><td>3 gang</td></tr> <tr><td>GW 16 304 TB</td><td>4 gang</td></tr> </table>	GW 16 302 TB	2 gang	GW 16 303 TB	3 gang	GW 16 304 TB	4 gang	<table border="0"> <tr><td>GW 16 302 VT</td><td>2 gang</td></tr> <tr><td>GW 16 303 VT</td><td>3 gang</td></tr> <tr><td>GW 16 304 VT</td><td>4 gang</td></tr> </table>	GW 16 302 VT	2 gang	GW 16 303 VT	3 gang	GW 16 304 VT	4 gang	<table border="0"> <tr><td>GW 16 302 MC</td><td>2 gang</td></tr> <tr><td>GW 16 303 MC</td><td>3 gang</td></tr> <tr><td>GW 16 304 MC</td><td>4 gang</td></tr> </table>	GW 16 302 MC	2 gang	GW 16 303 MC	3 gang	GW 16 304 MC	4 gang
	GW 16 302 TB	2 gang																			
	GW 16 303 TB	3 gang																			
	GW 16 304 TB	4 gang																			
GW 16 302 VT	2 gang																				
GW 16 303 VT	3 gang																				
GW 16 304 VT	4 gang																				
GW 16 302 MC	2 gang																				
GW 16 303 MC	3 gang																				
GW 16 304 MC	4 gang																				
TONER BLACK	SLATE	GOLD																			
																					
<table border="0"> <tr><td>GW 16 302 TN</td><td>2 gang</td></tr> <tr><td>GW 16 303 TN</td><td>3 gang</td></tr> <tr><td>GW 16 304 TN</td><td>4 gang</td></tr> </table>	GW 16 302 TN	2 gang	GW 16 303 TN	3 gang	GW 16 304 TN	4 gang	<table border="0"> <tr><td>GW 16 302 VA</td><td>2 gang</td></tr> <tr><td>GW 16 303 VA</td><td>3 gang</td></tr> <tr><td>GW 16 304 VA</td><td>4 gang</td></tr> </table>	GW 16 302 VA	2 gang	GW 16 303 VA	3 gang	GW 16 304 VA	4 gang	<table border="0"> <tr><td>GW 16 302 MO</td><td>2 gang</td></tr> <tr><td>GW 16 303 MO</td><td>3 gang</td></tr> <tr><td>GW 16 304 MO</td><td>4 gang</td></tr> </table>	GW 16 302 MO	2 gang	GW 16 303 MO	3 gang	GW 16 304 MO	4 gang	
GW 16 302 TN	2 gang																				
GW 16 303 TN	3 gang																				
GW 16 304 TN	4 gang																				
GW 16 302 VA	2 gang																				
GW 16 303 VA	3 gang																				
GW 16 304 VA	4 gang																				
GW 16 302 MO	2 gang																				
GW 16 303 MO	3 gang																				
GW 16 304 MO	4 gang																				

Leather	RUBY						
							
	<table border="0"> <tr><td>GW 16 302 PR</td><td>2 gang</td></tr> <tr><td>GW 16 303 PR</td><td>3 gang</td></tr> <tr><td>GW 16 304 PR</td><td>4 gang</td></tr> </table>	GW 16 302 PR	2 gang	GW 16 303 PR	3 gang	GW 16 304 PR	4 gang
GW 16 302 PR	2 gang						
GW 16 303 PR	3 gang						
GW 16 304 PR	4 gang						

Modularity			
	2 gang	3 gang	4 gang

ICE PLATES

Glass





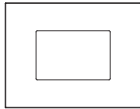
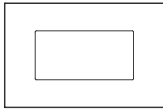

WHITE	TITANIUM
	
GW 16 903 CB 3 gang GW 16 904 CB 4 gang	GW 16 903 CT 3 gang GW 16 904 CT 4 gang
BLACK	
	
GW 16 903 CN 3 gang GW 16 904 CN 4 gang	

Modularity

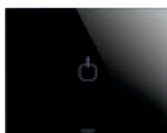
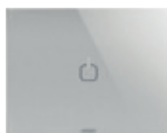
	
3 gang	4 gang

ICE TOUCH PLATES

Glass (for touch modules)

WHITE	BLACK	TITANIUM
		
GW 16 951 CB 1 symbol	GW 16 951 CN 1 symbol	GW 16 951 CT 1 symbol
		
GW 16 952 CB 2 symbols	GW 16 952 CN 2 symbols	GW 16 952 CT 2 symbols
		
GW 16 953 CB 3 symbols	GW 16 953 CN 3 symbols	GW 16 953 CT 3 symbols

ICE TOUCH KNX PLATES









Glass (for KNX/EASY TOUCH push-button panels modules with interchangeable icons)

WHITE

GW 16 946 CB
BLACK

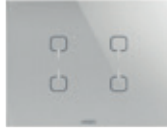
GW 16 946 CN
TITANIUM

GW 16 946 CT

Glass (for KNX/Easy touch push-button panels modules)

WHITE	BLACK	TITANIUM
		
GW 16 962 CB 2 symbols	GW 16 962 CN 2 symbols	GW 16 962 CT 2 symbols
		
GW 16 964 CB 4 symbols	GW 16 964 CN 4 symbols	GW 16 964 CT 4 symbols
		
GW 16 966 CB 6 symbols	GW 16 966 CN 6 symbols	GW 16 966 CT 6 symbols

Quick coupling

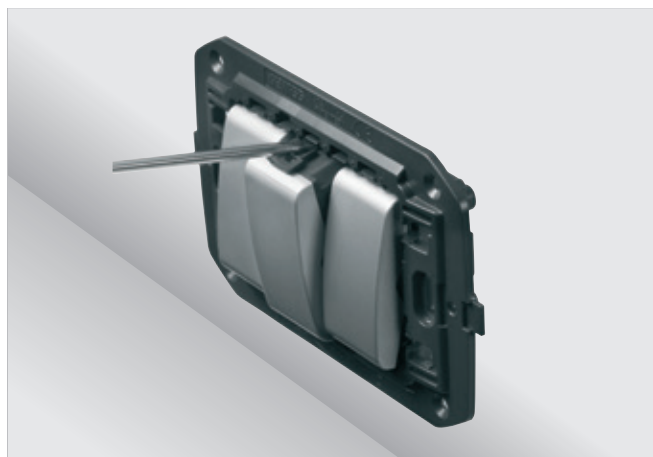
The front coupling of the Chorus devices makes the support assembly and release operations quick and easy, facilitating the assembly and wiring phases even after the frame has been fixed onto the box. The solidity of the frame support guarantees the best performance also on not completely smooth surfaces.



Unlimited functions in reduced space

Limited spaces no longer restrict the number of Chorus devices that can be installed. With the same available space in fact, the 1/2-module commands increase the number of command points that can be installed and allow even reduced spaces to be better exploited. The 2- and 3-module button keys ensure rapid localisation of the point and easy activation.

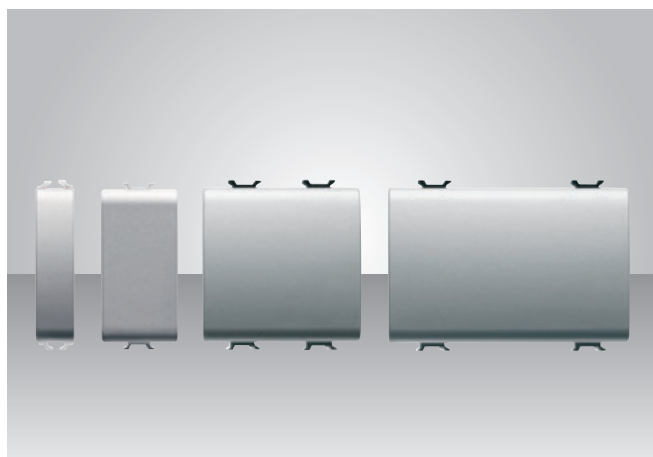

Half-module pitch

The frame supports are characterised by a half-module pitch that allows to create a wide range of combinations of Chorus devices thanks to their different modularities.

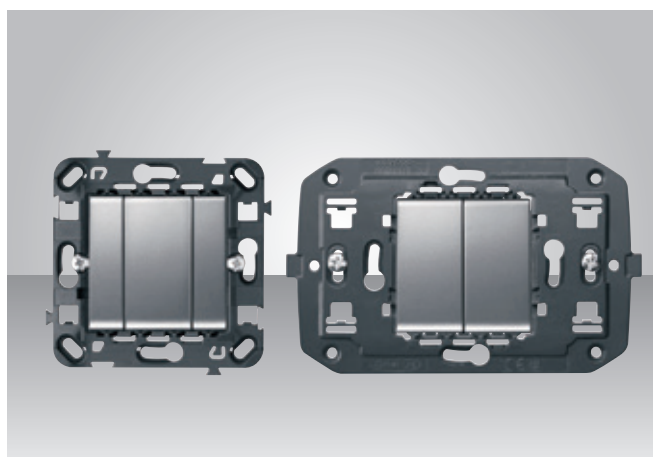

Reduced overall dimensions and easy wiring

All the commands are very shallow (starting from 20mm), to facilitate installation even in boxes with less spaces. Wiring is simplified thanks to the position of the terminals and the increased diameter of the holes. The double cut screws permit improved tightening of the terminals.

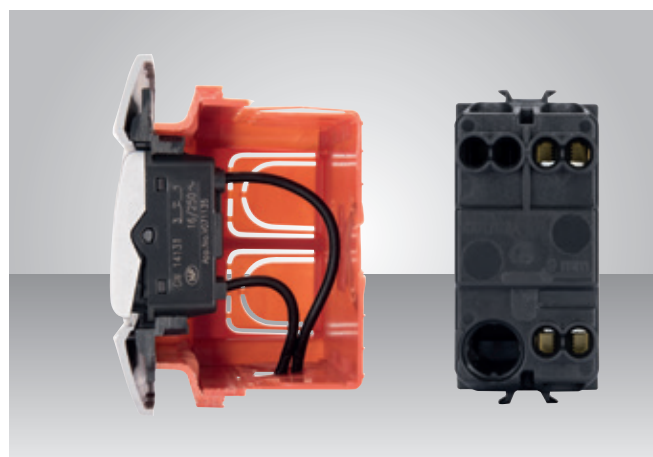

Localisation and functional signalling

The button keys are available in two different designs: with an illuminated diffuser for night-time localisation or with an illuminated window for signalling. The buttons can be personalised by choosing from LEDs in many colors or by using the numerous illuminated symbols.



Colour range

Four different colours with three different finishes. The possibility to combine each component with all the plates. Glossy White: bright, versatile, doesn't attract dust. Glossy Ivory: classic and refined. Satin Black: a marked character of class and elegance. Glossy painted Titanium: innovative and trendy.



(*) Available for selected products only

Chorus PLATES AND MODULAR DEVICES

COMMAND

One-way switches																
	GW 10 001 1M-1P-16 AX	GW 10 002 1M-1P-16 AX Illuminable (*)	GW 10 003 1M-1P-16 AX Illuminable (*)	GW 10 021 1/2M-1P-10 AX	GW 10 022 1/2M-1P-10 AX Illuminable (*)	GW 10 031 2M-1P-16 AX	GW 10 032 2M-1P-16 AX Illuminable (*)	GW 10 033 2M-1P-16 AX Illuminable (*)	GW 10 041 3M-1P-16 AX							
	○●●○	○●●○	○●●○	○●●	○●●	○●●○	○●●○	○●●○	○●●							
	GW 10 042 3M-1P-16 AX Illuminable (*)	GW 10 043 3M-1P-16 AX Illuminable (*)	GW 10 044 1M-2P-16 AX	GW 10 004 1M-2P-16 AX	GW 10 005 1M-2P-16 AX Illuminable (*)	GW 10 006 1M-2P-10 AX With key	GW 10 007 1M-2P-25 AX Heavy-duty loads	GW 10 034 2M-2P-16 AX	GW 10 035 2M-2P-16 AX Illuminable (*)							
	○●●	○●●	○●●○	○●●○	○●●	○●●	○●●	○●●	○●●							
	Two-way switches															
		GW 10 051 1M-1P-16 AX	GW 10 052 1M-1P-16 AX Illuminable (*)	GW 10 053 1M-1P-16 AX Illuminable (*)	GW 10 054 1M-1P-10 AX With key	GW 10 061 1/2M-1P-10 AX	GW 10 071 2M-1P-16 AX	GW 10 091 1M-1P-16 AX	GW 10 092 1M-1P-16 AX Illuminable (*)	GW 10 093 1M-1P-16 AX Illuminable (*)	GW 10 101 2M-1P-16 AX					
		○●●○	○●●○	○●●○	○●●	○●●	○●●○	○●●○	○●●○	○●●○	○●●○					
GW 10 072 2M-1P-16 AX Illuminable (*)		GW 10 073 2M-1P-16 AX Illuminable (*)	GW 10 081 3M-1P-16 AX	GW 10 082 3M-1P-16 AX Illuminable (*)	GW 10 083 3M-1P-16 AX Illuminable (*)	GW 10 121 1M-1P-10 AX Positions 1-0-2	GW 10 122 1M-2P-10 AX Positions 1-0-2	GW 10 123 2M-1P-10 AX Positions 1-0-2	GW 10 112 3M-1P-16 AX Illuminable (*)	GW 10 113 3M-1P-16 AX Illuminable (*)						
○●●○		○●●○	○●●	○●●	○●●	○●●○	○●●○	○●●○	○●●○	○●●○						
Push-buttons																
		GW 10 131 1M-1P-NO-16 A	GW 10 132 1M-1P-NO-16 A Illuminable (*)	GW 10 133 1M-1P-NO-16 A Illuminable (*)	GW 10 136 1M-1P-NO-16 A With pull-cord	GW 10 137 1M-1P-NC-16 A	GW 10 138 1M-1P-NC-NO-16 A Stop	GW 10 139 1M-1P-NO-NC-16 A Start	GW 10 140 1M-1P-NO-NO-10 A With interlock	GW 10 141 1M-1P-NO-NO-16 A Double	GW 10 142 1M-1P-NO-16 A Green - Illuminable (*)	GW 10 143 1M-1P-NO-16 A Red - Illuminable (*)	GW 10 144 1M-1P-NO-16 A Opal - Illuminable (*)			
		○●●○	○●●○	○●●○	○●●○	○●●	○●●	○●●	○●●○	○●●○	○●●○	○●●○	○●●○			
	GW 10 151 1M-1P-NO-16 A Light - Illuminable (*)	GW 10 152 1M-1P-NO-16 A Key - Illuminable (*)	GW 10 153 1M-1P-NO-16 A Bell - Illuminable (*)	GW 10 161 1/2M-1P-NO-10 A	GW 10 162 1/2M-1P-NO-10 A Illuminable (*)	GW 10 171 2M-1P-NO-16 A	GW 10 172 2M-1P-NO-16 A Illuminable (*)	GW 10 173 2M-1P-NO-16 A Illuminable (*)	GW 10 181 3M-1P-NO-16 A	GW 10 182 3M-1P-NO-16 A Illuminable (*)	GW 10 183 3M-1P-NO-16 A Illuminable (*)	GW 10 134 1M-2P-NO-16 A	GW 10 135 1M-2P-NO-16 A Illuminable (*)	GW 10 145 1M-2P-NO-10 A With key	GW 10 191 2M-1P-NO-10 A With illuminated name plate	GW 10 192 3M-1P-NO-10 A With illuminated name plate
	○●●	○●●	○●●○	○●●	○●●	○●●○	○●●○	○●●○	○●●	○●●	○●●	○●●	○●●	○●●	○●●	○●●

○ White (GW 10 XXX)

● Black (GW 12 XXX)

● Titanium (GW 14 XXX)

○ Ivory (GW 11 XXX)

(*) supplied without LED signalling unit

COMMAND

One-way switches (quick wiring)											
	GW 10 031 F 2M-1P-16 AX	GW 10 032 F 2M-1P-16 AX Illuminable (*)	GW 10 033 F 2M-1P-16 AX Illuminable (*)	GW 10 034 F 2M-2P-16 AX	GW 10 035 F 2M-2P-16 AX Illuminable (*)						
Two-way switches (quick wiring)				Intermediate switches (quick wiring)							
	GW 10 071 F 2M-1P-16 AX	GW 10 072 F 2M-1P-16 AX Illuminable (*)	GW 10 073 F 2M-1P-16 AX Illuminable (*)		GW 10 101 F 2M-1P-16 AX	GW 10 102 F 2M-1P-16 AX Illuminable (*)	GW 10 103 F 2M-1P-16 AX Illuminable (*)				
Push-buttons (quick wiring)				Combined devices							
	GW 10 171 F 2M-1P-NO-16 A	GW 10 172 F 2M-1P-NO-16 A Illuminable (*)	GW 10 173 F 2M-1P-NO-16 A Illuminable (*)		GW 10 078 F Two-way switch 1P-16 AX+ Two-way switch 1P-16 AX	GW 10 159 F Two-way switch 1P-16 AX+ Push-button 1P-NO-16 A	GW 10 160 F Push-button 1P-NO-16 A+ Push-button 1P-NO-16 A				
Lens with illuminated symbol											
	GW 10 501 Transparent	GW 10 502 Light	GW 10 503 Stair light	GW 10 504 Table light	GW 10 505 Bell	GW 10 506 Fan	GW 10 507 Key	GW 10 508 Alarm	GW 10 509 ON		
	GW 10 531 One	GW 10 532 Two	GW 10 533 Three	GW 10 534 Four	GW 10 535 Five	GW 10 536 Six	GW 10 537 Seven	GW 10 538 Eight	GW 10 539 Nine	GW 10 540 Zero	
Interchangeable button keys							Interchangeable diffusers				
	GW 10 541 General	GW 10 542 With label	GW 10 543 Key	GW 10 544 Bell	GW 10 545 Vertical arrow	GW 10 546 Horizontal arrow		GW 10 547 Red	GW 10 548 Green	GW 10 549 Opal	GW 10 550 Amber
Blanking modules					Cable outputs						
	GW 10 197 1/2M	GW 10 195 1M	GW 10 198 2M	GW 10 199 3M		GW 10 196 1M	GW 10 194 2M				
Infrared					Relays						
	GW 10 591 Movement detector 1M-INO-3A	GW 10 592 Movement detector 2M-INO-16A	GW 10 597 1-channel receiver 1M-230V ac-50/60 Hz	GW 12 596 6-channel portable remote control		GW 10 721 Latching 1M-1P-10 AX-250V ac	GW 10 723 Latching, 4 sequences 1M-2P-10 AX-250V ac	GW 10 724 Monostable 1M-1P-10A 250V ac-1NO/1NC	GW 10 726 Call 1M-1P-NO/1NC-12V ac/dc		

○ White (GW 10 XXX) ● Black (GW 12 XXX) ● Titanium (GW 14 XXX) ○ Ivory (GW 11 XXX) (*) supplied without LED signalling unit

Chorus PLATES AND MODULAR DEVICES

POWER

Italian															
	GW 10 201 2P+E-10A-250V ac ○●●	GW 10 203 2P+E-16A-250V ac Dual amperage ○●●○	GW 10 213 2P+E-16A-250V ac Dual amperage	GW 10 223 2P+E-16A-250V ac Dual amperage	GW 10 233 2P+E-16A-250V ac Dual amperage	GW 10 208 2x2P+E-16A-250V ac Dual amperage ○●●	GW 10 209 3x2P+E-16A-250V ac Dual amperage ○●●								
	Italian/German						British								
		GW 10 204 2P+E-16A-250V ac Dual amperage ○●●	GW 10 205 2P+E-16A-250V ac ○●●	GW 10 214 2P+E-16A-250V ac Dual amperage - Illuminable (*)	GW 10 224 2P+E-16A-250V ac Dual amperage - Illuminable (*)	GW 10 234 2P+E-16A-250V ac Dual amperage - Illuminable (*)		GW 10 296 2P+E-13A-250V ac ○●●	GW 10 297 2P+E-15A-250V ac ○●●						
		German									Swiss				
			GW 10 241 2P+E-16A-250V ac ○●●○	GW 10 242 2P+E-16 A-250 V ac With lid ○●●○	GW 10 251 2P+E-16A-250V ac ○●●	GW 10 341 2P+E-16A-250V ac Front-tightening terminals ○●●		GW 10 351 2P+E-16A-250V ac Front-tightening terminals	GW 10 241 F 2P+E-16A-250V ac Quick wiring ○●●	GW 10 251 F 2P+E-16A-250V ac Quick wiring		GW 10 346 2P+E-10 A-250 V ac Type 13 ○			
			French												
GW 10 246 2P-16A-250V ac ○●●○	GW 10 247 2P+E-16A-250V ac ○●●○			GW 10 248 2P+E-16A-250V ac Front-tightening terminals ○●●	GW 10 258 2P+E-16A-250V ac Front-tightening terminals	GW 10 247 F 2P+E-16A-250V ac Quick wiring ○●●	GW 10 257 F 2P+E-16A-250V ac Quick wiring	GW 10 260 Accessory for dedicated lines							
Israeli					USA		Euro-American			Multistandard					
	GW 10 281 2P+E-16A-250V ac Illuminable (*) ○●●	GW 10 291 2P+E-16A-250V ac Illuminable (*) ○●●		GW 10 282 2P-10A-250V ac ○●●		GW 10 286 2P+E-15A-250/125V ac ○●●		GW 10 287 2P-15A-250/125V ac ○●●○	GW 10 288 2P+E-15A-250/125V ac ○●●○		GW 10 310 2P+E-10 A/250V ac - 15 A/127V ac ○●●				
	Chinese					Argentinian			Australian				Indian/South African		
		GW 10 391 2P+E-10 A-250 V ac ○●●		GW 10 392 2P+E-16 A-250 V ac ○●●				GW 10 301 2P+E-10A-250V ac ○●●			GW 10 306 2P+E-10A-250V ac ○●●	GW 10 307 2P+E-15A-250V ac ○●●		GW 10 298 2P+E-16A-250V ac ○●●	GW 10 299 2P+E-16A-250V ac ○●●
Interlocked switched socket-outlets								Shaver socket-outlet							
	GW 10 311 2P+E-16A-230V ac ○●●	GW 10 312 2P+E-16A-230V ac ○●●	GW 10 321 2P+E-16A-230V ac ○●●	GW 10 322 2P+E-16A-230V ac ○●●	GW 10 331 230V ac-50/60 Hz ○●●○										

○ White (GW 10 XXX)

● Black (GW 12 XXX)

● Titanium (GW 14 XXX)

○ Ivory (GW 11 XXX)

(*) supplied without LED signalling unit

DATA

TV male IEC	 GW 10 361 0 dB ○ ● ○ ○	 GW 10 362 5 dB ○ ● ●	 GW 10 363 10 dB ○ ● ●	 GW 10 364 14 dB ○ ● ●	TV-SAT female F	 GW 10 371 0 dB ○ ● ○ ○	 GW 10 372 5 dB ○ ● ●	 GW 10 373 10 dB ○ ● ●	 GW 10 374 14 dB ○ ● ●	TV and TV-SAT accessory GW 20 277 Terminal resistance 75 ohm
TV-FM-SAT	 GW 10 381 TV-FM 0 dB ○ ● ○ ○	 GW 10 382 TV-FM-SAT 0 dB ○ ● ○ ○	 GW 10 383 TV-SAT 0 dB ○ ● ○ ○	TV-SAT	 GW 10 367 IEC male 0dB ○ ● ●	 GW 10 377 F female 0dB ○ ● ●	Covers for antenna sockets	 GW 10 386 For combined TV-R sockets ○ ● ●	 GW 10 387 For combined TV-R-SAT sockets ○ ● ●	
Telephone socket-outlets	 GW 10 401 RJ11 ○ ● ○ ○	 GW 10 402 RJ11 IN/OUT ○ ● ●	 GW 10 403 RJ11 double ○ ● ●	 GW 10 405 French - 8 contacts ○ ● ●	 GW 10 406 British - 6 contacts ○ ● ●	 GW 10 410 RJ11 double with ADSL filter ○ ● ●	 GW 10 409 RJ11 ○ ● ●	Adapters for optical fibres	 GW 10 425 ST ○ ● ●	 GW 10 426 SC ○ ● ●
Data sockets	 GW 10 421 RJ45 cat. 5e UTP ○ ● ○ ○	 GW 10 422 RJ45 cat. 5e FTP ○ ● ○ ○	 GW 10 423 RJ45 cat. 6 UTP ○ ● ○ ○	 GW 10 424 RJ45 cat. 6 FTP ○ ● ○ ○	 GW 10 431 AMP/Keystone Jack ○ ● ○ ○	Connectors for conventional networks	 GW 10 441 SUB-D 9 contacts ○ ● ●	 GW 10 442 SUB-D 15 contacts ○ ● ●	 GW 10 443 SUB-D 25 contacts ○ ● ●	
Data sockets	 GW 10 434 RJ45 cat. 5e UTP ○ ● ●	 GW 10 436 RJ45 cat. 5e FTP ○ ● ●	 GW 10 435 RJ45 cat. 6 UTP ○ ● ●	 GW 10 437 RJ45 cat. 6 FTP ○ ● ●	 GW 10 433 AMP/Keystone Jack adapter ○ ● ●	SELV sockets	 GW 10 451 2P-6A-24V ○ ● ●	 GW 10 452 2P-6A-24V Polarised ○ ● ●		
Audio and video sockets	 GW 10 453 Double RCA ○ ● ●	 GW 10 454 Phonic circuits ○ ● ●	 GW 10 446 Female F coupling ○ ● ●	 GW 10 458 Speaker connector ○ ● ●	USB and HDMI couplers and sockets	 GW 10 459 USB socket ○ ● ●	 GW 38 056 HDMI coupler	 GW 38 057 USB coupler	USB power supply	 GW 10 450 Double USB power supply ○ ● ●

PROTECTION

Miniature circuit breakers	 GW 10 461 1P-6A-3 kA C-characteristic ○ ● ●	 GW 10 462 1P-10A-3 kA C-characteristic ○ ● ●	 GW 10 463 1P-16A-3 kA C-characteristic ○ ● ●	 GW 10 466 1P+N-6A-3 kA C-characteristic ○ ● ●	 GW 10 467 1P+N-10A-3 kA C-characteristic ○ ● ●	 GW 10 468 1P+N-16A-3 kA C-characteristic ○ ● ●	Protection devices	 GW 10 491 Fuse-holder In MAX=16A ○ ● ●	 GW 10 492 Surge protection device ○ ● ●
Residual miniature circuit breakers	 GW 10 482 1P+N-6A-3 kA-10 mA C-characteristic-A type ○ ● ●	 GW 10 485 1P+N-10A-3 kA-10 mA C-characteristic-A type ○ ● ●	 GW 10 488 1P+N-16A-3 kA-10 mA C-characteristic-A type ○ ● ●	 GW 10 483 1P+N-6A-3 kA-30 mA C-characteristic-A type ○ ● ●	 GW 10 486 1P+N-10A-3 kA-30 mA C-characteristic-A type ○ ● ●	 GW 10 489 1P+N-16A-3 kA-30 mA C-characteristic-A type ○ ● ●			

○ White (GW 10 XXX) ● Black (GW 12 XXX) ● Titanium (GW 14 XXX) ○ Ivory (GW 11 XXX)

Chorus PLATES AND MODULAR DEVICES

INDICATOR

Anti black-out lamps			Emergency lamps								
	GW 10 661 230V ac-50/60 Hz Extractable ○ ● ●	GW 10 662 230V ac-50/60 Hz ○ ● ● ●		GW 10 663 230V ac-50/60 Hz ○ ● ●	GW 10 666 230V ac-50/60 Hz ○ ● ●						
Ringers					Buzzers						
	GW 10 601 12V ac-50 Hz ○ ● ●	GW 10 602 230V ac-50 Hz ○ ● ● ●	GW 10 611 12V ac/dc Three independent inputs ○ ● ●	GW 10 612 230V ac-50 Hz Three independent inputs ○ ● ●		GW 10 606 12V ac-50 Hz ○ ● ●	GW 10 607 230V ac-50 Hz ○ ● ● ●				
Single indicator lamps									Double indicator lamps		
	GW 10 641 1/2M - Opal Illuminable (*) ○ ● ●	GW 10 642 1/2M - Green Illuminable (*) ○ ● ● ●	GW 10 643 1/2M - Red Illuminable (*) ○ ● ● ●	GW 10 644 1/2M - Amber Illuminable (*) ○ ● ● ●	GW 10 621 1M - Opal Illuminable (*) ○ ● ● ●	GW 10 622 1M - Green Illuminable (*) ○ ● ● ●	GW 10 623 1M - Red Illuminable (*) ○ ● ● ●	GW 10 624 1M - Amber Illuminable (*) ○ ● ● ●		GW 10 628 1M - Opal Illuminable (*) ○ ● ● ●	GW 10 629 1M - Red/Green Illuminable (*) ○ ● ● ●
Protruding indicator lamps					Stair riser lamps						
	GW 10 631 2M-12V ac/dc-230V ac-50/60 Hz - Opal ○ ● ●	GW 10 632 2M-12V ac/dc-230V ac-50/60 Hz - Green ○ ● ● ●	GW 10 633 2M-12V ac/dc-230V ac-50/60 Hz - Red ○ ● ● ●	GW 10 634 2M-12V ac/dc-230V ac-50/60 Hz - Amber ○ ● ● ●		GW 10 651 2M Opal ○ ● ● ●	GW 10 656 4M Opal ○ ● ● ●				

ENERGY MANAGEMENT, CLIMATE, COMFORT AND TECHNICAL ALARMS

Timed thermostats				Thermostats			
	GW 10 703 230V ac-50/60 Hz ○ ● ●	GW 10 701 White Wall-mounting	GW 14 701 Titanium Wall-mounting		GW 16 972 CB ○ GW 16 972 CN ● GW 16 972 CT ● Thermo ICE WiFi thermostat 12-24 V ac/dc	GW 10 720 Power supply 100/240 V ac-50/60 Hz-12 V dc	GW 10 705 230V ac-50/60 Hz ○ ● ● ●
Clock/Alarm/Thermometer		Electronic timer		Timers			
	GW 10 708 230V ac-50/60 Hz ○ ● ●		GW 10 581 230V ac-50/60 Hz Daily/Weekly ○ ● ●		GW 10 583 1M ○ ● ●	GW 10 582 2M ○ ● ●	
Detectors					Accessories		
	GW 10 711 LPG 12V ac/dc ○ ● ●	GW 10 712 Methane gas 12V ac/dc ○ ● ●	GW A1 514 Flood alarm ZigBee	GW A1 521 1-channel actuator ZigBee 230 V ac-50 Hz		GW 10 720 Power supply 100/240 V ac-50/60 Hz-12 V dc	GW 30 522 GAS solenoid valve 3/4"-230 V ac-12 VA

○ White (GW 10 XXX)

● Black (GW 12 XXX)

● Titanium (GW 14 XXX)

○ Ivory (GW 11 XXX)

(*) supplied without LED signalling unit

REGULATION

Dimmers								
	GW 10 561 Resistive 100-500W 230V ac-50/60 Hz ○●●	GW 10 564 ▲ Resistive 100-900W Inductive 40-300 VA 230V ac-50/60 Hz ○●●○	GW 10 567 Resistive 100-500W Inductive 100-500 VA With two-way switch 230V ac-50/60 Hz ○●●○	GW 10 566 Resistive 20-160W LED 4-160 W Electr. transf. 40-160/4-110 W With two-way switch 230 V ac-50/60 Hz ○●●	GW 10 572 A ① Res./Ind. 40-300W LED 5-150W 230V ac-50/60 Hz ○●●	GW 10 573 A ① Res./Ind. 40-300 W LED 5-150 W 230 V ac-50/60 Hz ○●●○	GW 10 568 Resistive 60-500W Inductive 60-500 VA 230V ac-50 Hz ○●●	GW 10 574 For air agitators Inductive 55-80 VA 230V ac-50 Hz ○●●

COMMAND

TOUCH commands				TOUCH command modules			
	GW 10 904 One-way switch 1M-230V ac-50 Hz ○●●	GW 10 905 Dimmer 1M-230V ac-50 Hz ○●●	GW 10 906 Command duplicator 1M-230V ac-50 Hz ○●●		GW 10 907 One-way switch module 1M-230V ac-50 Hz	GW 10 908 Dimmer module 1M-230V ac-50 Hz	GW 10 909 Command duplicator module 1M-230V ac-50 Hz

Electronic push-buttons							
	GW 10 915 Universal 1M-1P-NO ○●●	GW 10 912 1M-NO-230V ac Backlit ○●●	GW 10 913 For BUS inputs 1M-1P-NO Backlit ○●●	GW 10 916 For BUS inputs 1M-1P-NO Backlit ○●●	GW 10 917 For BUS inputs 2M-1P-NO Backlit ○●●	GW 10 918 For BUS inputs 2M-1P-NO Backlit ○●●	GW 10 914 With interlock 1M-1P-NO+NO ○●●

HOTEL COMPONENTS

Badge switch		Interchangeable button keys				Double indicator lamp	
	GW 10 039 2M-1P-NO-16 AX Illuminable (*) ○●●○		GW 10 731 DND ○●●	GW 10 732 MUR ○●●	GW 10 733 DND + MUR ○●●		GW 10 736 1M - Opal DND + MUR Illuminable (*) ○●●

ACCESSORIES

LED signalling units							Cartridge lamps			Keys		
	GW 10 881 Blue 230V ac-50/60 Hz	GW 10 882 White 230V ac-50/60 Hz	GW 10 883 Red 230V ac-50/60 Hz	GW 10 884 Green 230V ac-50/60 Hz	GW 10 885 Amber 230V ac-50/60 Hz	GW 10 894 White 12/24V ac/dc		GW 20 902 White 12V-56x36	GW 20 903 White 24V-56x36		GW 20 901 For one-way/ two-way switches	GW 30 912 For push-buttons

SUPPORTS



















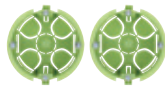

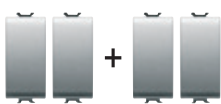

Supports for round/square boxes			Support for round/square and rectangular boxes		
	GW 16 821 With fixing clutches - 2 gang GW 16 823 With long fixing clutches - 2 gang	GW 16 822 With screw (not included) 2 gang		GW 16 802 With screw - 2 gang	
Supports for rectangular boxes					
	GW 16 803 With screw - 3 gang	GW 16 804 With screw - 4 gang GW 16 824 With screw (not included) 4 gang (for French std boxes)	GW 16 805 With screw - 6 gang GW 16 825 With screw (not included) 6 gang (for French std boxes)	GW 16 808 With screw - 4+4 gang	GW 16 812 With screw - 6+6 gang

▲ =Articles designed exclusively for export to a limited number of countries not belonging to the EU (or candidates for membership) or the European Free Trade Association. Check with GEWISS Customer Service to make sure the product meets the regulations of the country in question before importing it.

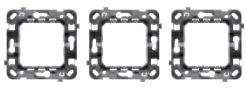
○ White (GW 10 XXX) ● Black (GW 12 XXX) ● Titanium (GW 14 XXX) ○ Ivory (GW 11 XXX)

(*) supplied without LED signalling unit
① Available from September 2018

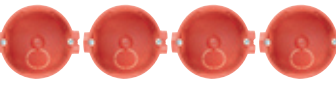
Chorus PLATES AND MODULAR DEVICES

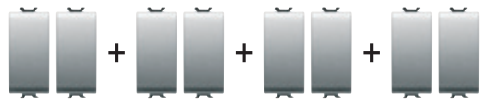
	FLUSH-MOUNTING BOXES	SUPPORTS	DEVICES
2M	 GW 24 231  GW 24 234 PM  GW 24 232  GW 24 208  GW 24 209	 GW 16 822  GW 16 821 - GW 16 823	
2+2M HORIZONTAL	 2 x GW 24 231  2 x GW 24 234 PM  2 x GW 24 232	 2 x GW 16 822  2 x GW 16 821 - GW 16 823	
2+2+2M HORIZONTAL	 3 x GW 24 231  3 x GW 24 234 PM  3 x GW 24 232	 3 x GW 16 822  3 x GW 16 821 - GW 16 823	
2+2+2+2M HORIZONTAL	 4 x GW 24 231  4 x GW 24 234 PM  4 x GW 24 232	 4 x GW 16 822  4 x GW 16 821 - GW 16 823	

PLATES

**ONE
INTERNATIONAL**



GW 16 122 xx

**GEO
INTERNATIONAL**



GW 16 422 xx

**LUX
INTERNATIONAL**



GW 16 222 xx

**ONE
INTERNATIONAL**



GW 16 123 xx

**GEO
INTERNATIONAL**



GW 16 423 xx

**LUX
INTERNATIONAL**



GW 16 223 xx

**ONE
INTERNATIONAL**



GW 16 126 xx

**GEO
INTERNATIONAL**



GW 16 426 xx

**LUX
INTERNATIONAL**



GW 16 226 xx

**ONE
INTERNATIONAL**







GW 16 128 xx

**LUX
INTERNATIONAL**



GW 16 228 xx

Chorus PLATES AND MODULAR DEVICES

	FLUSH-MOUNTING BOXES	SUPPORTS	DEVICES
2+2M VERTICAL 57MM	 <p>GW 24 282 PM</p>	 <p>2 x GW 16 822 (*)</p> <p>(*) Couple two supports GW 16 822 vertically by breaking off the removable wings on each one.</p>	
2+2M VERTICAL	 <p>2 x GW 24 231</p>  <p>2 x GW 24 234 PM</p>  <p>2 x GW 24 232</p>	 <p>2 x GW 16 822</p>  <p>2 x GW 16 821 - GW 16 822 - GW 16 823</p>	
2+2+2M VERTICAL	 <p>3 x GW 24 231</p>  <p>3 x GW 24 234 PM</p>  <p>3 x GW 24 232</p>	 <p>3 x GW 16 822</p>  <p>3 x GW 16 821 - GW 16 822 - GW 16 823</p>	
2+2+2+2M VERTICAL	 <p>4 x GW 24 231</p>  <p>4 x GW 24 234 PM</p>  <p>4 x GW 24 232</p>	 <p>4 x GW 16 822</p>  <p>4 x GW 16 821 - GW 16 822 - GW 16 823</p>	

PLATES

**ONE
INTERNATIONAL**



GW 16 125 xx

**LUX
INTERNATIONAL**



GW 16 225 xx

**ONE
INTERNATIONAL**



GW 16 124 xx

**GEO
INTERNATIONAL**



GW 16 424 xx

**LUX
INTERNATIONAL**



GW 16 224 xx

**ONE
INTERNATIONAL**



GW 16 127 xx

**GEO
INTERNATIONAL**



GW 16 427 xx

**LUX
INTERNATIONAL**



GW 16 227 xx

**ONE
INTERNATIONAL**















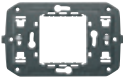

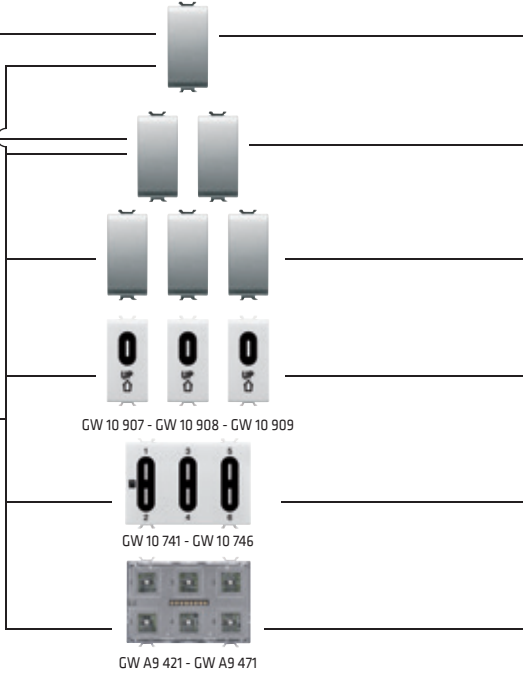

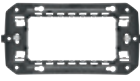



GW 16 129 xx

**LUX
INTERNATIONAL**

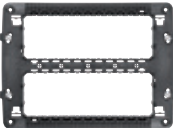

GW 16 229 xx

Chorus PLATES AND MODULAR DEVICES

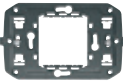
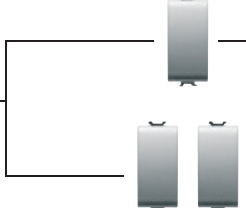
	FLUSH-MOUNTING BOXES	SUPPORTS	DEVICES
3M	 GW 24 403  GW 24 403 PM	 GW 16 802  GW 16 803	 GW 10 907 - GW 10 908 - GW 10 909 GW 10 741 - GW 10 746 GW A9 421 - GW A9 471
4M	 GW 24 404  GW 24 404 PM	 GW 16 804	
6M	 GW 24 406  GW 24 406 PM	 GW 16 806	
4+4M	 GW 24 237  GW 24 237 PM	 GW 16 808	
6+6M	 GW 24 238	 GW 16 812	
2M	 GW 24 231  GW 24 232  GW 24 234 PM	 GW 16 802	

PLATES

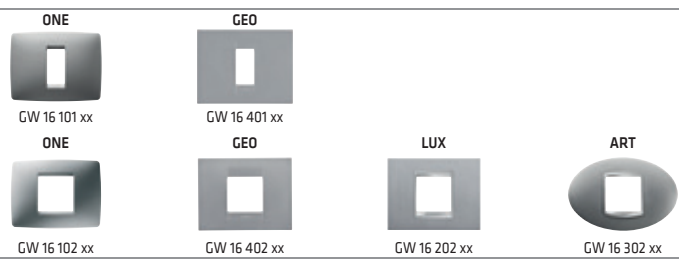
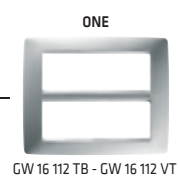
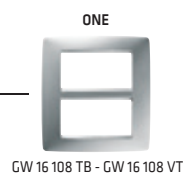

The devices

The new Chorus domestic range, aimed at markets that rely on the British Standard (BS), develops around a core of monobloc devices that perform all basic functions, which can be extended as required thanks to the wide offering of Chorus modular devices. The range is available in the three colours: glossy white, satin black and painted titanium.



British Standard

Monobloc devices are developed for British Standard flush-mounting boxes, 3x3-inches (1-gang box) and 3x6-inches (2-gang box), with screw fixing. The compact size of monobloc devices also enables them to be easily installed starting from boxes with a depth of 25mm.



Slim shapes, Italian design

The range of monobloc devices is characterised by round lines and unmistakable shapes, inspired by Italian design. GEO plates, with their essential, minimalistic outline and the LUX plates, with their modern, elegant geometries, can meet any installation and aesthetic needs.



Wiring terminals

Reduced depth to provide greater room for cabling, large terminals with captive screws for easy cable fitting, extension of earth connection (in socket-outlets and double pole switches) also in the flush-mounting box thanks to metal threaded inserts on the support frame.



Enhanced functions

Basic functions provided with monobloc devices can be extended thanks to the Chorus devices' modular offering: from modular components with reduced footprint (from 20mm) available in 1/2-, 1-, 2- and 3- module formats to electronic devices such as dimmers, thermostats, chronothermostats, etc., up to domotic equipment. The Chorus BS offering, therefore, supports the creation of limitless functions that can meet any application needs.

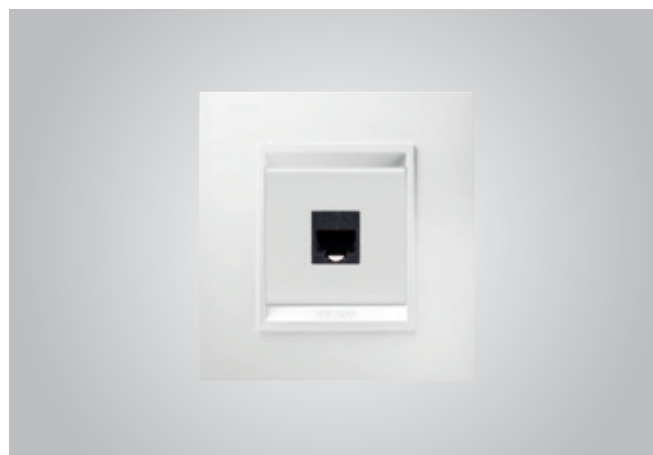

Chorus integration with BS boxes



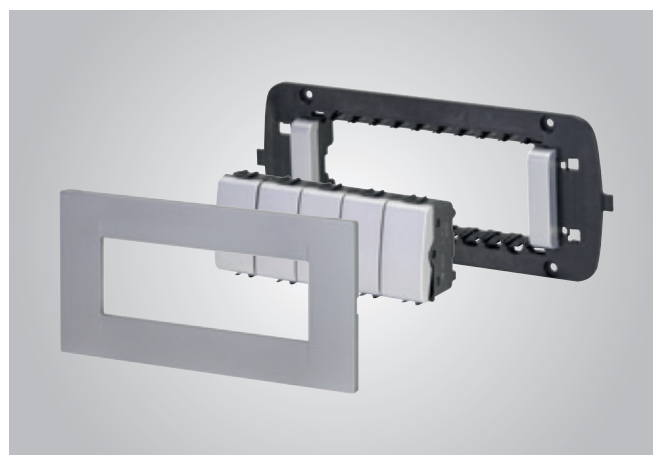

The integration of Chorus modular devices in BS boxes is possible thanks to the specific support frames that can house up to 2 Chorus modules (in 3x3-inches boxes) or up to 5 Chorus modules (in 3x6-inches boxes). The support frames have to be completed with GEO or LUX plates.



NOTE: the Chorus modular devices are characterized by depths that can vary according on their functions, so please check they properly fit in the boxes.





Chorus British Standard PLATES AND DEVICES

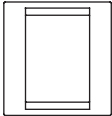



GEO PLATES





Technopolymer	MILK WHITE	IVORY	TITANIUM	SLATE
				
	GW 16 436 TB 1 gang GW 16 437 TB 2 gang	GW 16 436 TI 1 gang GW 16 437 TI 2 gang	GW 16 436 VT 1 gang GW 16 437 VT 2 gang	GW 16 436 VA 1 gang GW 16 437 VA 2 gang
		Painted technopolymer		



Modularity		
	1 gang	2 gang

LUX PLATES



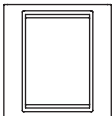

Technopolymer	MILK WHITE	MONOCHROME MILK WHITE	TONER BLACK	CHROME	GOLD
					
	GW 16 236 TB 1 gang GW 16 237 TB 2 gang	GW 16 236 YB 1 gang GW 16 237 YB 2 gang	GW 16 236 TN 1 gang GW 16 237 TN 2 gang	GW 16 236 MC 1 gang GW 16 237 MC 2 gang	GW 16 236 MO 1 gang GW 16 237 MO 2 gang
				Metallised technopolymer	

Technopolymer - Wood finish	MAPLE	WENGE	CHERRY	Technopolymer - Stone finish	SAND
					
	GW 16 236 LA 1 gang GW 16 237 LA 2 gang	GW 16 236 LW 1 gang GW 16 237 LW 2 gang	GW 16 236 LC 1 gang GW 16 237 LC 2 gang		GW 16 236 RS 1 gang GW 16 237 RS 2 gang

Metal	BLACK ALUMINIUM	BRUSHED STAINLESS STEEL	Glass	ICE	AQUAMARINE
					
	GW 16 236 MA 1 gang GW 16 237 MA 2 gang	GW 16 236 MI 1 gang GW 16 237 MI 2 gang		GW 16 236 CG 1 gang GW 16 237 CG 2 gang	GW 16 236 CA 1 gang GW 16 237 CA 2 gang





Modularity		
	1 gang	2 gang

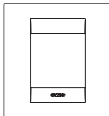
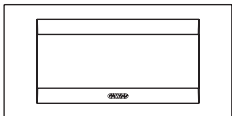



GEO PLATES





Technopolymer	MILK WHITE	IVORY	Painted technopolymer	TITANIUM	SLATE
					
	GW 16 422 TB 1 gang GW 16 406 TB 2 gang	GW 16 422 TI 1 gang GW 16 406 TI 2 gang		GW 16 422 VT 1 gang GW 16 406 VT 2 gang	GW 16 422 VA 1 gang GW 16 406 VA 2 gang

Modularity		
	1 gang	2 gang - 5 module

LUX PLATES

Technopolymer	MILK WHITE	MONOCHROME MILK WHITE	TONER BLACK	Metallised technopolymer	CHROME	GOLD
						
	GW 16 222 TB 1 gang GW 16 206 TB 2 gang	GW 16 222 YB 1 gang GW 16 238 YB 2 gang	GW 16 222 TN 1 gang GW 16 206 TN 2 gang		GW 16 222 MC 1 gang GW 16 206 MC 2 gang	GW 16 222 MO 1 gang GW 16 206 MO 2 gang





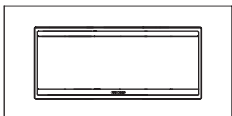



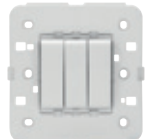

Technopolymer - Wood finish	MAPLE	WENGE	CHERRY	Technopolymer - Stone finish	SAND
					
	GW 16 222 LA 1 gang GW 16 238 LA 2 gang	GW 16 222 LW 1 gang GW 16 238 LW 2 gang	GW 16 222 LC 1 gang GW 16 238 LC 2 gang		GW 16 222 RS 1 gang GW 16 238 RS 2 gang

Metal	BLACK ALUMINIUM	BRUSHED STAINLESS STEEL	Glass	ICE	AQUAMARINE
					
	GW 16 222 MA 1 gang GW 16 238 MA 2 gang	GW 16 222 MI 1 gang GW 16 206 MI 2 gang		GW 16 222 CG 1 gang GW 16 206 CG 2 gang	GW 16 222 CA 1 gang GW 16 206 CA 2 gang







Modularity		
	1 gang	2 gang - 5 module

Chorus British Standard PLATES AND DEVICES





COMMAND

One-way switches				DP switches			
	GW 10 038 1P - 16 AX - 1 gang ○ ● ●	GW 10 012 1P - 16 AX - 2 gang ○ ● ●	GW 10 045 M 1P - 10 AX - 3 gang ○ ● ●		GW 10 008 M 2P - 20 A - 1 gang Backlit ○ ● ●	GW 10 009 M 2P - 20 A - 1 gang Water Heater - Backlit ○ ● ●	GW 10 011 M 2P - 45 A - 1 gang Backlit ○ ● ●
					Cooker Control		
GW 10 075 1P - 16 AX - 1 gang ○ ● ●	GW 10 056 1P - 16 AX - 2 gang ○ ● ●	GW 10 085 M 1P - 10 AX - 3 gang ○ ● ●	GW 10 360 M Cooker unit - 2P - 45A Backlit ○				



POWER

Switched socket-outlets						
	GW 10 336 M 2P+E-13 A-250 V ac ○ ● ●	GW 10 337 M 2P+E-13 A-250 V ac Backlit ○ ● ●	GW 10 356 M 2P+E-13 A-250 V ac with USB ○	GW 10 338 M 2P+E-13 A-250 V ac Twin ○ ● ●	GW 10 339 M 2P+E-13 A-250 V ac Twin - Backlit ○ ● ●	GW 10 358 M 2P+E-13 A-250 V ac Twin - with USB ○





FUSED CONNECTION UNITS

Switched			Unswitched		
	GW 10 493 M 2P-13 A ○	GW 10 494 M 2P-13 A Backlit ○		GW 10 495 M 2P-13 A ○	GW 10 496 M 2P-13 A Backlit ○

CABLE OUTLETS

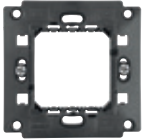
Cable Outlets		
	GW 10 497 M 20 A ○	GW 10 498 M 45 A ○

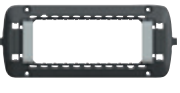

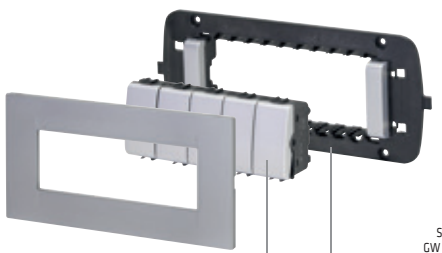











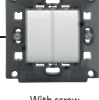

SUPPORTS FOR CHORUS MODULAR DEVICES

Support for BS 1 gang box		NOTE: the Chorus modular devices are characterized by depths that can vary according on their functions, so please check they properly fit in the boxes.		
	GW 16 831 1 gang		Chorus modular devices	Support GW 16 831
Supports for BS 2 gang box				
	GW 16 837 2 gang - 5 module White	GW 16 838 2 gang - 5 module Black	GW 16 839 2 gang - 5 module Titanium	
				Support GW 16 837, GW 16 838 or GW 16 839

○ White (GW 10 XXX)

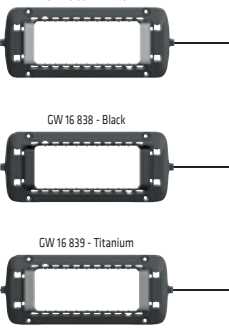
● Black (GW 12 XXX)

○ Titanium (GW 14 XXX)

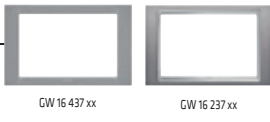
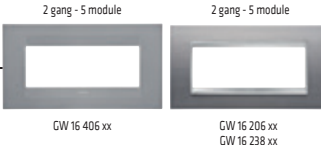
BOXES	SUPPORTS	DEVICES	PLATES
 <p>1 gang BS backbox (Centre distance 60.3 mm)</p>	 <p>GW 16 831 With screw</p>	 <p>GW 1x 008 M GW 1x 009 M GW 1x 011 M With screw</p>  <p>GW 1x 336 M GW 1x 337 M GW 10 356 M With screw</p>  <p>GW 10 493 M GW 10 494 M GW 10 495 M GW 10 496 M GW 10 497 M GW 10 498 M With screw</p>  <p>GW 1x 038 GW 1x 075 With screw</p>  <p>GW 1x 012 GW 1x 056 With screw</p>  <p>GW 1x 045 M GW 1x 085 M With screw</p>  <p>2 x 1 module (*)</p>  <p>1 x 2 module (*)</p>	 <p>GEO - 1 gang LUX - 1 gang GW 16 436 xx GW 16 236 xx</p>  <p>GEO - 1 gang LUX - 1 gang GW 16 422 xx GW 16 222 xx</p>
 <p>2 gang BS backbox (Centre distance 120.6 mm)</p>	 <p>GW 16 837 - White GW 16 838 - Black GW 16 839 - Titanium With screw</p>	 <p>GW 1x 338 M - GW 1x 339 M GW 10 358 M - GW 10 360 M With screw</p>  <p>5 x 1 module (*)</p>  <p>3 x 1 module + 1 x 2 module (*)</p>  <p>1 x 1 module + 2 x 2 module (*)</p>	 <p>GEO - 2 gang LUX - 2 gang GW 16 437 xx GW 16 237 xx</p>  <p>GEO 2 gang - 5 module LUX 2 gang - 5 module GW 16 406 xx GW 16 206 xx GW 16 238 xx</p>

(*) From Chorus modular devices range

Installation flexibility

A universal system offering the maximum application flexibility. A range that can be used with both flush-mounting and surface-mounting solutions, in all indoor and outdoor environments.

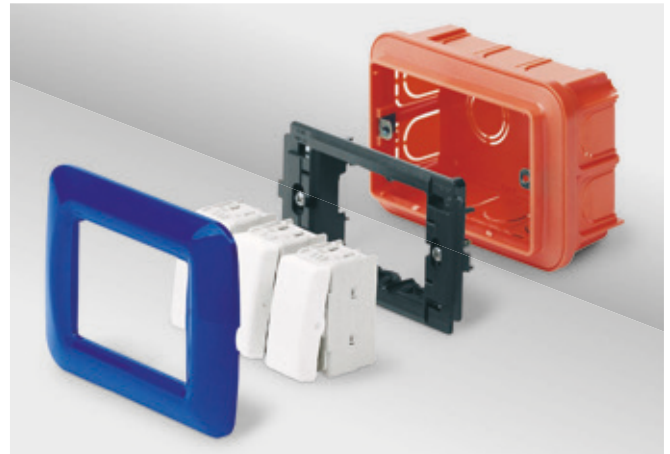

Integration

Total integration with the 27 COMBI range, which proposes a wide variety of containers for protected watertight systems in full view, for garden systems and for combined applications for protection and distribution.

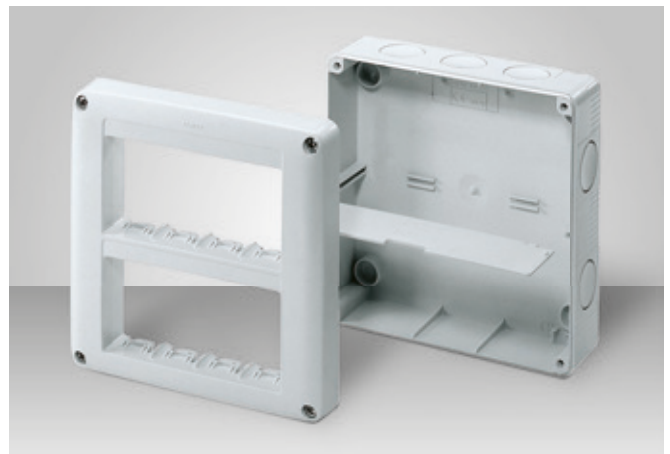

Complete range

The SYSTEM range includes commands, energy socket-outlets (Italian and international standard), TV-SAT socket-outlets, USB power supplies, protections, indicators, connectors, devices for comfort and special components with high qualitative characteristics.



Command devices

The command devices are available in the 16AX version with a nominal current of 16A, also for fluorescent loads. Also for the safe control of inductive/capacitive load management over time.

16AX



System solutions

The SYSTEM devices use a wide range of accessories and can be installed and assembled in any electrical system:

- in flush-mounting and surface-mounting rectangular boxes
- in boxes for interface with mini trunking
- on profiles and system device trunking
- on DIN rail and mobile adapters



Colour range

SYSTEM WHITE is elegant, safe and cost-effective, offering a complete practical system of plates that are ideal for both indoors and outdoors. SYSTEM BLACK is designed for the most modern environments of the residential and commercial sectors, offering a refined contrast between the satin black button key and the wide range of colours for the glossy plates.



Glossy white
GW 20 XXX

Satin black
GW 21 XXX

TOP SYSTEM PLATES

Technopolymer

CLOUD WHITE



GW 22 501	1 gang
GW 22 502	2 gang
GW 22 503	3 gang
GW 22 504	4 gang
GW 22 506	6 gang
GW 22 507	4+4 gang
GW 22 508	6+6 gang

TONER BLACK



GW 22 511	1 gang
GW 22 512	2 gang
GW 22 513	3 gang
GW 22 514	4 gang
GW 22 516	6 gang
GW 22 517	4+4 gang

Painted technopolymer

TITANIUM



GW 22 601	1 gang
GW 22 602	2 gang
GW 22 603	3 gang
GW 22 604	4 gang
GW 22 606	6 gang
GW 22 607	4+4 gang
GW 22 608	6+6 gang

SLATE



GW 22 611	1 gang
GW 22 612	2 gang
GW 22 613	3 gang
GW 22 614	4 gang
GW 22 616	6 gang
GW 22 617	4+4 gang
GW 22 618	6+6 gang

Metallised technopolymer

SOFT CHROME



GW 22 651	1 gang
GW 22 652	2 gang
GW 22 653	3 gang
GW 22 654	4 gang
GW 22 656	6 gang
GW 22 657	4+4 gang

ANTIQUE GOLD



GW 22 661	1 gang
GW 22 662	2 gang
GW 22 663	3 gang
GW 22 664	4 gang
GW 22 666	6 gang
GW 22 667	4+4 gang

Technopolymer-classic colour

ENGLISH WALNUT



GW 22 671	1 gang
GW 22 672	2 gang
GW 22 673	3 gang
GW 22 674	4 gang
GW 22 676	6 gang
GW 22 677	4+4 gang

TOP SYSTEM PLATES

Technopolymer - pastel colours

GERANIUM RED



- GW 22 521 1 gang
- GW 22 522 2 gang
- GW 22 523 3 gang
- GW 22 524 4 gang
- GW 22 526 6 gang
- GW 22 527 4+4 gang

VENETIAN GREEN



- GW 22 541 1 gang
- GW 22 542 2 gang
- GW 22 543 3 gang
- GW 22 544 4 gang
- GW 22 546 6 gang
- GW 22 547 4+4 gang

SKY BLUE



- GW 22 561 1 gang
- GW 22 562 2 gang
- GW 22 563 3 gang
- GW 22 564 4 gang
- GW 22 566 6 gang
- GW 22 567 4+4 gang

CLASSIC BURGUNDY



- GW 22 531 1 gang
- GW 22 532 2 gang
- GW 22 533 3 gang
- GW 22 534 4 gang
- GW 22 536 6 gang
- GW 22 537 4+4 gang

RACING GREEN



- GW 22 551 1 gang
- GW 22 552 2 gang
- GW 22 553 3 gang
- GW 22 554 4 gang
- GW 22 556 6 gang
- GW 22 557 4+4 gang

JAZZ BLUE



- GW 22 571 1 gang
- GW 22 572 2 gang
- GW 22 573 3 gang
- GW 22 574 4 gang
- GW 22 576 6 gang
- GW 22 577 4+4 gang

CORN YELLOW



- GW 22 581 1 gang
- GW 22 582 2 gang
- GW 22 583 3 gang
- GW 22 584 4 gang
- GW 22 586 6 gang
- GW 22 587 4+4 gang

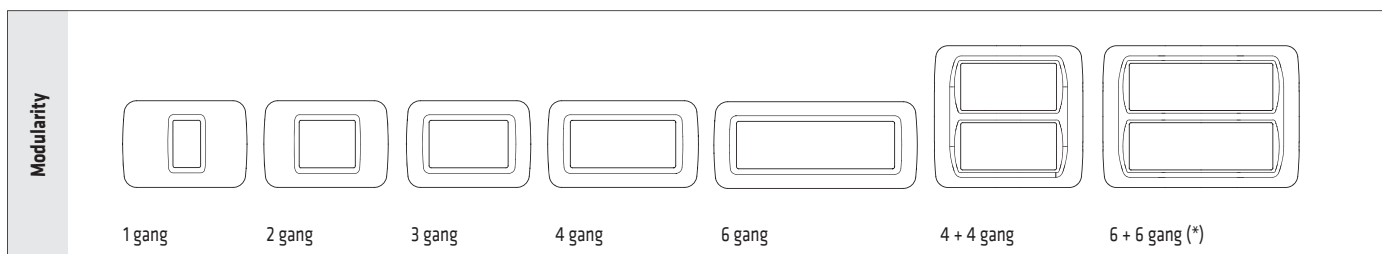

(*) Cloud White, Slate and Titanium

VIRNA PLATES

Technopolymer

CLOUD WHITE



GW 22 101	1 gang
GW 22 102	2 gang
GW 22 103	3 gang
GW 22 104	4 gang
GW 22 106	6 gang
GW 22 107	4+4 gang
GW 22 108	6+6 gang

TONER BLACK



GW 22 111	1 gang
GW 22 112	2 gang
GW 22 113	3 gang
GW 22 114	4 gang
GW 22 116	6 gang
GW 22 117	4+4 gang

Painted technopolymer

TITANIUM



GW 22 281	1 gang
GW 22 282	2 gang
GW 22 283	3 gang
GW 22 284	4 gang
GW 22 286	6 gang
GW 22 287	4+4 gang
GW 22 288	6+6 gang

SLATE



GW 22 291	1 gang
GW 22 292	2 gang
GW 22 293	3 gang
GW 22 294	4 gang
GW 22 296	6 gang
GW 22 297	4+4 gang
GW 22 298	6+6 gang

Metallised technopolymer

SOFT CHROME



GW 22 251	1 gang
GW 22 252	2 gang
GW 22 253	3 gang
GW 22 254	4 gang
GW 22 256	6 gang
GW 22 257	4+4 gang

ANTIQUE GOLD



GW 22 261	1 gang
GW 22 262	2 gang
GW 22 263	3 gang
GW 22 264	4 gang
GW 22 266	6 gang
GW 22 267	4+4 gang

Technopolymer-classic colour

ENGLISH WALNUT



GW 22 271	1 gang
GW 22 272	2 gang
GW 22 273	3 gang
GW 22 274	4 gang
GW 22 276	6 gang
GW 22 277	4+4 gang

VIRNA PLATES

Technopolymer-pastel colours

GERANIUM RED



GW 22 121	1 gang
GW 22 122	2 gang
GW 22 123	3 gang
GW 22 124	4 gang
GW 22 126	6 gang
GW 22 127	4+4 gang

VENETIAN GREEN



GW 22 141	1 gang
GW 22 142	2 gang
GW 22 143	3 gang
GW 22 144	4 gang
GW 22 146	6 gang
GW 22 147	4+4 gang

SKY BLUE



GW 22 161	1 gang
GW 22 162	2 gang
GW 22 163	3 gang
GW 22 164	4 gang
GW 22 166	6 gang
GW 22 167	4+4 gang

CLASSIC BURGUNDY



GW 22 131	1 gang
GW 22 132	2 gang
GW 22 133	3 gang
GW 22 134	4 gang
GW 22 136	6 gang
GW 22 137	4+4 gang

RACING GREEN



GW 22 151	1 gang
GW 22 152	2 gang
GW 22 153	3 gang
GW 22 154	4 gang
GW 22 156	6 gang
GW 22 157	4+4 gang

JAZZ BLUE



GW 22 171	1 gang
GW 22 172	2 gang
GW 22 173	3 gang
GW 22 174	4 gang
GW 22 176	6 gang
GW 22 177	4+4 gang

CORN YELLOW



GW 22 181	1 gang
GW 22 182	2 gang
GW 22 183	3 gang
GW 22 184	4 gang
GW 22 186	6 gang
GW 22 187	4+4 gang

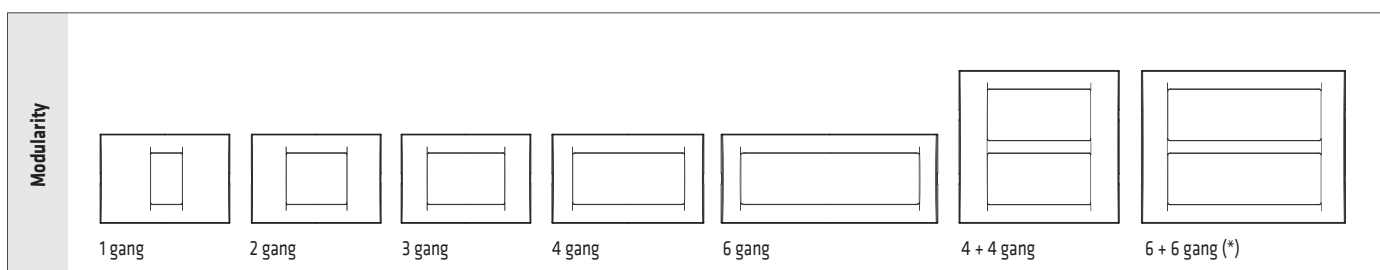

(*) Cloud White, Slate and Titanium

System PLATES AND MODULAR DEVICES

COMMAND

One-way switches													
	GW 20 571 1M-1P-16 AX	GW 20 572 1M-1P-16 AX Backlit 230V ac	GW 20 583 1M-1P-16 AX Illuminable (*)	GW 20 503 1M-2P-16 AX	GW 20 504 1M-2P-16 AX Backlit 230V ac	GW 20 584 1M-2P-16 AX Illuminable (*)	GW 20 005 1M-2P-10 AX With key	GW 20 585 1M-2P-25 AX Heavy-duty loads					
	○ ●	○ ●	○ ●	○ ●	○ ●	○ ●	○ ●	○ ●					
	Two-way switches						Intermediate switches						
		GW 20 576 1M-1P-16 AX	GW 20 577 1M-1P-16 AX Backlit 230V ac	GW 20 588 1M-1P-16 AX Illuminable (*)	GW 20 008 1M-1P-10 AX With key	GW 20 589 2M-1P-16 AX Illuminable (*)		GW 20 579 1M-1P-16 AX	GW 20 580 2M-1P-16 AX Illuminable (*)				
		○ ●	○ ●	○ ●	○ ●	○ ●		○ ●	○ ●				
	Push-buttons												
		GW 20 510 1M-1P-NO-10A	GW 20 515 Backlit 230V ac GW 20 516 Backlit 12/24V	GW 20 529 1M-1P-NO-10A Illuminable (*)	GW 20 531 1M-1P-NC-10 A Illuminable (*)	GW 20 511 1M-1P-NO-10 A Key	GW 20 512 1M-1P-NO-10A Bell	GW 20 513 1M-1P-NO-10 A Light	GW 20 514 1M-1P-NO-10 A Stair light	GW 20 530 1M-2P-NO-10 A With key	GW 20 522 1M-1P-NO+NC-10 A Start	GW 20 523 1M-1P-NC+NO-10A Stop	
○ ●		○ ●	○ ●	○ ●	○ ●	○ ●	○ ●	○ ●	○ ●	○ ●	○ ●		
GW 20 520 1M-1P-NO+NO-10 A With interlock		GW 20 521 1M-1P-NO+NO-10 A With interlock	GW 20 519 1M-1P-NC-10A	GW 20 517 1M-2P-NO-10A	GW 20 591 2M-1P-NO-10 A With Illuminable name plate	GW 20 024 3M-1P-NO-10 A With Illuminable name plate	GW 20 527 2M-1P-NO-10A Illuminable (*)	GW 20 518 1M-2P-NO-10 A With pull-cord					
○ ●		○ ●	○ ●	○ ●	○ ●	○ ●	○ ●	○ ●					
Three-way switches					Miniature lamps		Cartridge lamps						
		GW 20 559 1M-1P-10 AX Positions 1-0-2	GW 20 528 1M-1P-10 AX Positions 1-0-2	GW 20 560 1M-2P-10 AX Positions 1-0-2		GW 10 893 12/24V ac/dc		GW 20 902 56x36 12V ac/dc					
		○ ●	○ ●	○		White		White					
Lens with illuminated symbol													
	GW 20 533 Neutral	GW 20 537 Key	GW 20 538 Bell	GW 20 539 Light	GW 20 549 Triangle	GW 20 550 Bell	GW 20 551 Light	GW 20 595 ON	GW 20 561 1	GW 20 562 2	GW 20 563 3	GW 20 564 4	GW 20 565 5
		GW 20 540 General services	GW 20 542 General services	GW 20 592 Technical services	GW 20 593 Technical services	GW 20 596 Technical services	GW 20 597 Technical services	GW 20 594 OFF	GW 20 566 Numerical services	GW 20 567 Numerical services	GW 20 568 Numerical services	GW 20 569 Numerical services	GW 20 570 Numerical services
	Infrared	Relay						Blanking modules and cable output					
			GW 20 821 Movement detector 1M-1NO-3A	GW 20 071 Latching 1M-1P-10A-250V ac	GW 20 072 Latching 1M-2P-10A-250V ac	GW 20 074 Monostable 1M-1P-10A 250V ac-1NO/NC	GW 20 076 Call 1M-1P-NO/NC-12V ac/dc		GW 20 056 1M	GW 20 073 2M	GW 20 058 1M Cable output		
			○ ●	○ ●	○ ●	○ ●	○ ●		○ ●	○ ●	○ ●		

(*) Supplied without miniature lamp unit.

○ White (GW 20 XXX)

● Black (GW 21 XXX)

POWER

Italian										
	GW 20 201 2P+E-10A-250V ac ○ ●	GW 20 203 2P+E-16A-250V ac Dual amperage ○ ●	GW 20 295 2P+E-16A-250V ac Dual amperage	GW 20 281 2P+E-16A-250V ac Dual amperage	GW 20 286 2P+E-16A-250V ac Dual amperage	GW 20 291 2x2P+E-16A-250V ac Dual amperage ○ ●				
Italian/German						Swiss				
	GW 20 205 2P+E-16A-250V ac ○ ●	GW 20 246 2P+E-16A-250V ac Dual amperage ○ ●	GW 20 296 2P+E-16A-250V ac Dual amperage	GW 20 282 2P+E-16A-250V ac Dual amperage	GW 20 287 2P+E-16A-250V ac Dual amperage		GW 20 351 2P+E-10A-250V ac Type 12 ○ ●			
German					French					
	GW 20 265 2P+E-16A-250V ac ○ ●	GW 20 297 2P+E-16A-250V ac	GW 20 283 2P+E-16A-250V ac	GW 20 288 2P+E-16A-250V ac		GW 20 206 2P-16A-250V ac ○ ●	GW 20 207 2P+E-16A-250V ac ○ ●	GW 20 312 2P+E-16A-250V ac		
British			Australian			Euro-American/USA				
	GW 20 208 2P+E-13A-250V ac ○ ●	GW 20 209 2P+E-16A-250V ac ○ ●		GW 20 357 2P+E-10A-250V ac ○ ●	GW 20 356 2P+E-15A-250V ac ○ ●		GW 20 212 2P+E-10/15A 250/125V ac ○ ●	GW 20 214 2P+E-15A-125V ac ○ ●	GW 20 216 2P+E-15A-250V ac ○ ●	
Argentinian		Israeli					Special socket-outlets			
	GW 20 248 2P+E-10A-250V ac ○ ●		GW 20 220 2P+E-16A-250V ac Illuminable (*) ○ ●	GW 20 298 2P+E-16A-250V ac Illuminable (*)	GW 20 299 2P+E-16A-250V ac Illuminable (*)	GW 20 320 2P-10A-250V ac ○		GW 20 239 SELV 2P-6A-24V ○ ●	GW 20 234 SELV 2P-6A-24V Polarised ○ ●	GW 20 241 For loudspeaker ○ ●















○ White (GW 20 XXX)

● Black (GW 21 XXX)















(*) Supplied without miniature lamp unit.

System PLATES AND MODULAR DEVICES





DATA

TV-SAT	 F female GW 20 391 - 0 dB GW 20 396 - 5 dB GW 20 392 - 10 dB GW 20 393 - 14 dB	 IEC male GW 20 381 - 0 dB GW 20 386 - 5 dB GW 20 382 - 10 dB GW 20 383 - 14 dB	 IEC female GW 20 228 - 0 dB GW 20 229 - 20 dB GW 20 230 - Term. 20 dB	 GW 20 277 Terminal resistance 75 ohm	Telephone socket-outlets	 GW 20 251 RJ11	 GW 20 235 French - 8 contacts	 GW 20 272 British - 6 contacts
Data sockets	 RJ45 - UTP GW 20 685 Cat. 6 GW 20 684 Cat. 6 GW 20 271 Cat. 5e	 RJ45 - FTP GW 20 686 Cat. 6 GW 20 243 Cat. 5e	 Adapters GW 20 266 IBM GW 20 267 SYSTIMAX Commscope GW 20 270 AMP/Keystone Jack	 GW 20 237 BNC 50/75/93 ohm	 GW 20 238 Unwired enclosure for SUB-D 9/15/25 PIN			
USB and HDMI couplers	 GW 38 056 HDMI coupler	 GW 38 057 USB coupler	USB power supply	 GW 20 361 Double USB power supply				

POWER, COMFORT AND CLIMATE MANAGEMENT

Dimmer	 GW 20 802 Resistive 100-500W 230V ac-50/60 Hz	 GW 20 811 Resistive 100-500W Inductive 100-500 VA With two-way switch 230V ac-50/60 Hz	 GW 20 803 Resistive 100-900W Inductive 40-300 VA 230V ac-50/60 Hz	 GW 20 828 Resistive 60-500W Inductive 60-500 VA 230V ac-50/60 Hz	Electronic timer	 GW 20 825 230V ac-50/60 Hz Daily/Weekly	Timer	 GW 20 810 2M
Climate control	 GW 20 852 Thermostat 230V ac-50/60 Hz	 GW 20 827 Timed thermostat 230V ac-50/60 Hz	 GW 10 701 Timed thermostat white Wall-mounting	 GW 14 701 Timed thermostat titanium Wall-mounting				
Automatic circuit breakers	 Miniature circuit breakers 3 kA C-characteristic	 Residual miniature circuit breakers 3 kA C-characteristic	Protection devices	 GW 20 423 Surge protection device	 GW 20 401 Fuse-holder In MAX=16A			

HOTEL COMPONENTS















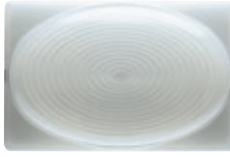

Badge switch	 GW 20 820 1P-NO-10A Backlit 230 V ac	Shaver socket-outlet	 GW 20 841 Shaver socket-outlet 230V ac-50/60 Hz	Climate control	 GW 20 853 Thermostat for fan-coil 230V ac-50/60 Hz	Three-way switch	 GW 20 651 1M-1P-10 AX DND + MUR	Double indicator lamp	 GW 20 656 1M - Opal DND + MUR - 230V ac
---------------------	---	-----------------------------	--	------------------------	--	-------------------------	--	------------------------------	--

▲ =Articles designed exclusively for export to a limited number of countries not belonging to the EU (or candidates for membership) or the European Free Trade Association. Check with GEWISS Customer Service to make sure the product meets the regulations of the country in question before importing it.





○ White (GW 20 XXX)

● Black (GW 21 XXX)

INDICATOR AND TECHNICAL ALARMS

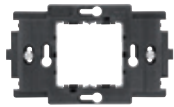
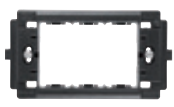
Anti-blackout lamps	 GW 20 833 230V ac-50/60 Hz Removable ○ ●	 GW 20 835 230V ac-50/60 Hz ○ ●	Ringers and buzzers	 GW 20 613 - 12V ac GW 20 616 - 230V ac Ringers ○ ●	 GW 20 617 - 12V ac GW 20 620 - 230V ac Buzzers ○ ●	 GW 20 643 - 230V ac GW 20 641 - 12V ac/dc Three independent inputs ○ ●	
Indicator lamps	 Flat diffuser Illuminable (*) ○ ●	 Flat diffuser complete with lamp ○ ●	 GW 20 634 Stair riser lamp 2M ○ ●	 Flat diffuser 12/24V ac/dc ○ GW 20 601 ● GW 20 623 ● GW 20 624 ● GW 20 625 ● GW 20 626	 Protruding diffuser 12/24V ac/dc ○ GW 20 602 ● GW 20 627 ● GW 20 628 ● GW 20 629 ● GW 20 630	 GW 20 622 Lamp-holder E27 ●	
Detectors	 GW 20 867 Methane gas 12V ac/dc ○ ●	 GW 20 868 LPG 12V ac/dc ○ ●	 GW A1 514 Flood alarm ZigBee	 GW A1 521 1-channel actuator ZigBee 230 V ac-50 Hz	Accessories	 GW 10 720 Power supply 100/240 V ac-50/60 Hz-12 V dc	 GW 30 522 GAS solenoid valve 3/4"-230 V ac-12 VA



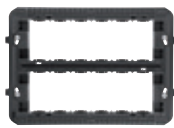













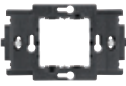



















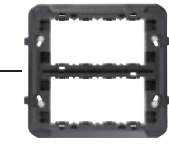



SUPPORTS

Support for square and rectangular boxes	 GW 24 262 With screw - 2 gang	Supports for rectangular boxes	 GW 24 201 With screw - 3 gang	 GW 24 202 With screw - 4 gang	 GW 24 230 With screw - 6 gang
			 GW 24 240 With screw - 4+4 gang	 GW 24 241 With screw - 6+6 gang	

○ White (GW 20 XXX) ● Black (GW 21 XXX)

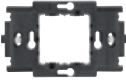
(*) Supplied without miniature lamp unit.

System PLATES AND MODULAR DEVICES

	FLUSH-MOUNTING BOXES	SUPPORTS	DEVICES	PLATES	
3M	 GW 24 403	 GW 24 201		TOP SYSTEM  GW 22 xx1	VIRNA  GW 22 xx1
	 GW 24 403 PM	 GW 24 262		TOP SYSTEM  GW 22 xx2	VIRNA  GW 22 xx2
		 GW 24 201		TOP SYSTEM  GW 22 xx3	VIRNA  GW 22 xx3
4M	 GW 24 404	 GW 24 202		TOP SYSTEM  GW 22 xx4	VIRNA  GW 22 xx4
	 GW 24 404 PM				
6M	 GW 24 406	 GW 24 230		TOP SYSTEM  GW 22 xx6	VIRNA  GW 22 xx6
	 GW 24 406 PM				
4+4M	 GW 24 237	 GW 24 240		TOP SYSTEM  GW 22 xx7	VIRNA  GW 22 xx7
	 GW 24 237 PM				
6+6M	 GW 24 238	 GW 24 241		TOP SYSTEM  GW 22 xx8	VIRNA  GW 22 xx8
2M	 GW 24 231	 GW 24 262		TOP SYSTEM  GW 22 xx2	VIRNA  GW 22 xx2

Wall-mounting enclosures and modular components

Great versatility

The modular containers are extremely easy to install, thanks to the considerable space left inside them for wiring.

In addition, a number of containers can be installed side by side, so it's possible to create configurations tailor-made for every type of need.

For greater safety, the compartments can even be internally divided with the aid of suitable functional elements.

IP40

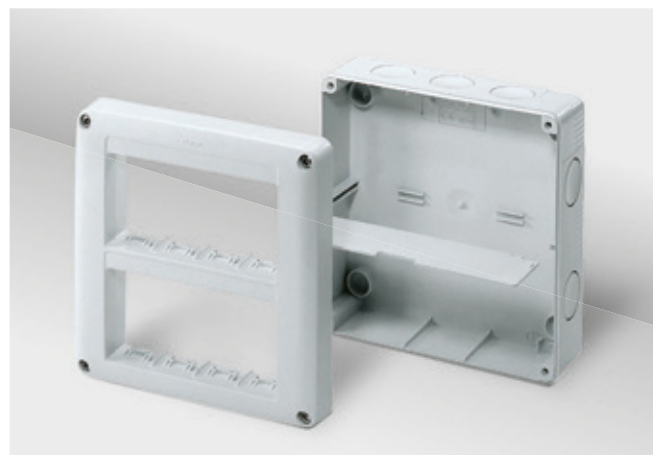

High protection degree

The perfect watertight seal is guaranteed by the door closure system and the gasket couplings. The special transparent membrane with notches makes it easier to feel and identify the button keys. The door clicks open, simply by pressing it upwards. The range also includes complete devices and containers for the garden (pole head and pole bracket versions).

IP55 / IP65

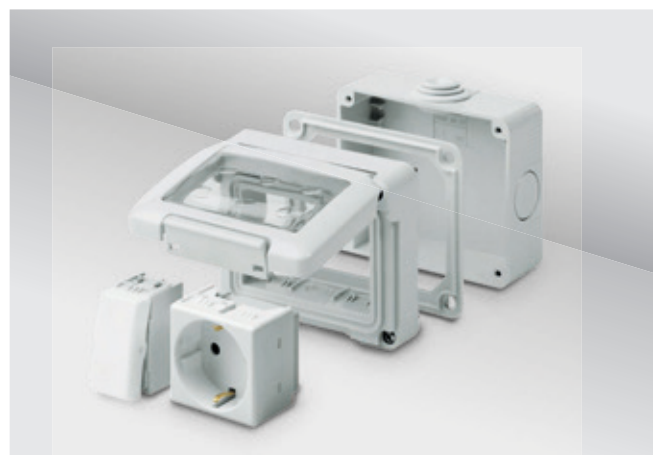

Special versions

The COMBI DIN version consists of protected multipurpose containers with compartment and transparent door for DIN rail modular devices, and compartments for installing SYSTEM devices.

The COMBI 22 models have reinforced fronts for fixing indicator lights, containers for push-buttons, 22-mm commands and indicators.



27 Combi WALL-MOUNTING ENCLOSURES AND MODULAR COMPONENTS

COMBI SYSTEM 40 ENCLOSURES

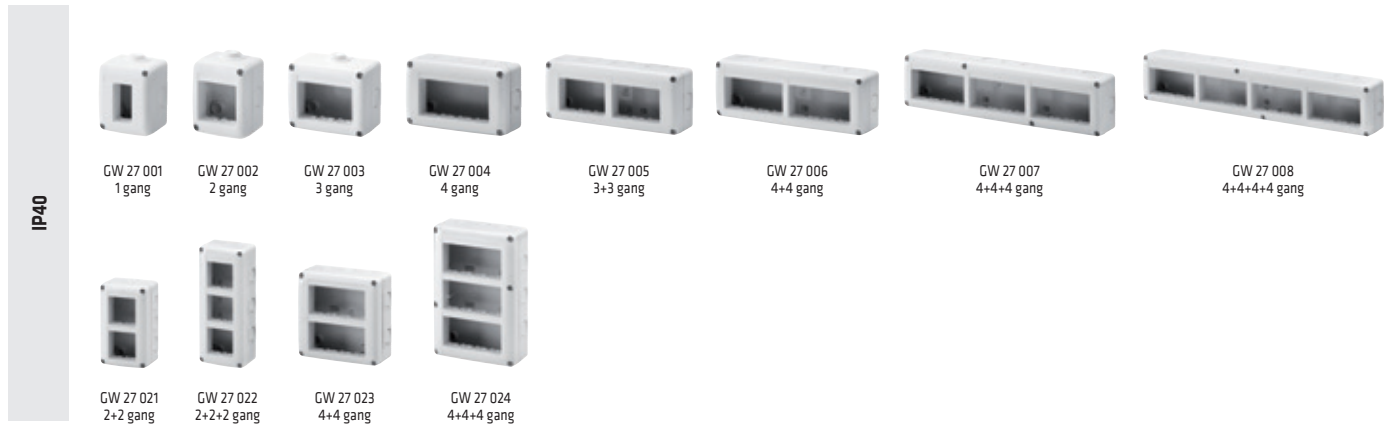

COMBI-DIN ENCLOSURES

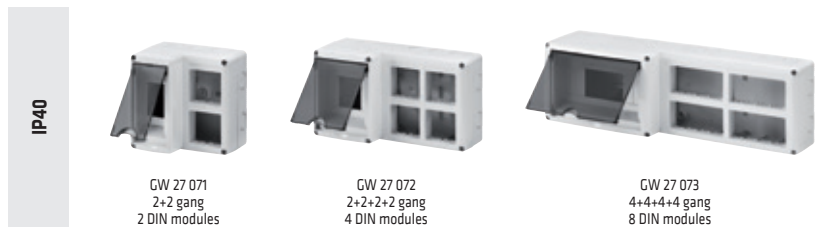

ENCLOSURES FOR MINI TRUNKING USED AS SKIRTING AND FRAMING

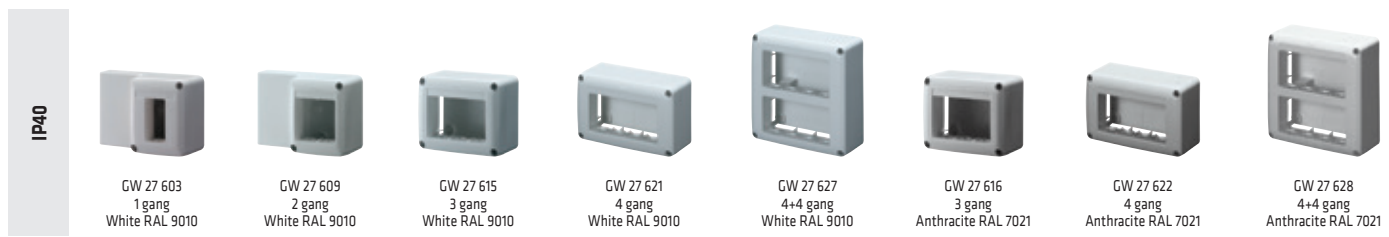

ENCLOSURES COMPLETE WITH SYSTEM DEVICES

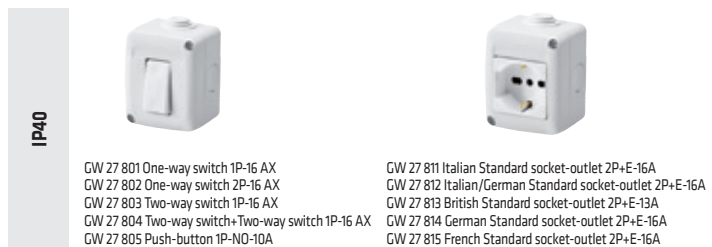



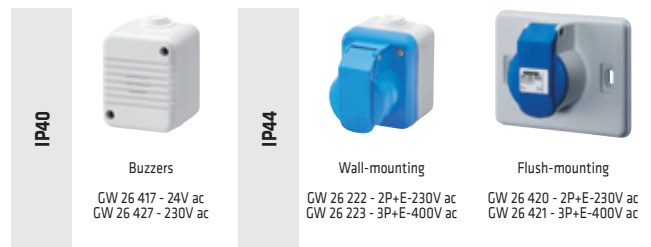





COMPLETE DEVICES





COMBI 22 ENCLOSURES FOR Ø 22MM OPERATORS



COMBI SYSTEM 55/65 ENCLOSURES

IP55	 GW 27 041 1 gang	 GW 27 042 2 gang	 GW 27 043 3 gang	 GW 27 044 4 gang	 GW 27 051 4+4 gang	 GW 27 052 4+4+4 gang
IP55	 GW 27 056 3 gang Post head	 GW 27 057 3 gang Post bracket	IP65	 GW 27 062 2 gang		

WATERTIGHT COVERS (FOR Q-DIN, Q-BOX)

IP55	 GW 27 401 2 gang 75x85 mm-IP55 Gray RAL 7035	For application on Q-DIN, junction boxes, PTC, IB range flanged lids, Q-BOX and panels	IP65	 GW 27 403 2 gang 75x85 mm-IP65 Grey RAL 7035	For application on Q-DIN, junction boxes, PTC, IB range flanged lids, Q-BOX and panels
-------------	---	--	-------------	---	--





WATERTIGHT PLATES (FOR FLUSH-MOUNTING RECTANGULAR BOXES)

IP55	 GW 22 451 - 3 gang GW 22 461 - 4 gang Cloud white	 GW 22 452 - 3 gang GW 22 462 - 4 gang Toner black	 GW 22 453 - 3 gang GW 22 463 - 4 gang Grey RAL 7035
-------------	--	---	---

ENCLOSURES COMPLETE WITH SYSTEM DEVICES

IP55	 GW 27 831 One-way switch 1P-16 AX GW 27 832 One-way switch 2P-16 AX GW 27 833 Two way switch 1P-16 AX GW 27 834 Two way switch+Two way switch 1P-16 AX GW 27 835 Push-button 1P-NO-10 A	 GW 27 841 Italian standard socket-outlet 2P+E-16 A GW 27 842 Italian/German standard socket-outlet 2P+E-16 A GW 27 843 British standard socket-outlet 2P+E-13 A GW 27 844 German standard socket-outlet 2P+E-16 A GW 27 845 French standard socket-outlet 2P+E-16 A	 GW 27 836 Push-button 1P-NO-10 A With illuminable name plate
-------------	--	--	--





COMPLETE DEVICES

IP55	 Indicator lamps 230 V ac	<ul style="list-style-type: none"> ● GW 27 415 ● GW 27 416 ● GW 27 417 ● GW 27 418 ● GW 27 419 	 Electronic flashlights	<ul style="list-style-type: none"> ● GW 27 421 24 V ac ● GW 27 422 230 V ac ● GW 27 423 24 V ac ● GW 27 424 230 V ac 	IP65	 GW 27 431 B IR movement detector 230 V ac	 GW 27 432 Twilight sensor 230 V ac
-------------	--	---	---	--	-------------	---	---

COMPLEMENTARY ITEMS

Complementary items	 GW 27 402	 GW 26 406	 GW 44 622
	 GW 26 407	 GW 27 441 Vertical division	 GW 27 442 Horizontal division

SHAVER SOCKET-OUTLETS

Flush-mounting	 GW 27 861 - With base GW 27 866 - Without base	 GW 27 862 - RAL 1013 With base GW 27 865 - RAL 1013 Without base GW 27 863 - RAL 9010 With base	Wall-mounting	 GW 27 864 RAL 1013 - 230V ac With base	Accessories	 GW 27 867 Flush-mounting box GW 27 868 Wall-mounting box, white
-----------------------	--	---	----------------------	---	--------------------	---

Dahlia range

The Dahlia monobloc devices have been developed for those countries where round boxes are typically used. A wide range of devices available in white and ivory colors, with glossy finish, expandable for enhanced functions thanks to the Chorus modular devices.



Dahlia plates

A wide choice of plates, realized in technopolymer in seven colors with glossy finish and in many modularities, installable indifferently in horizontal or in vertical position. A special plate has been designed for the double german and French socket-outlets.

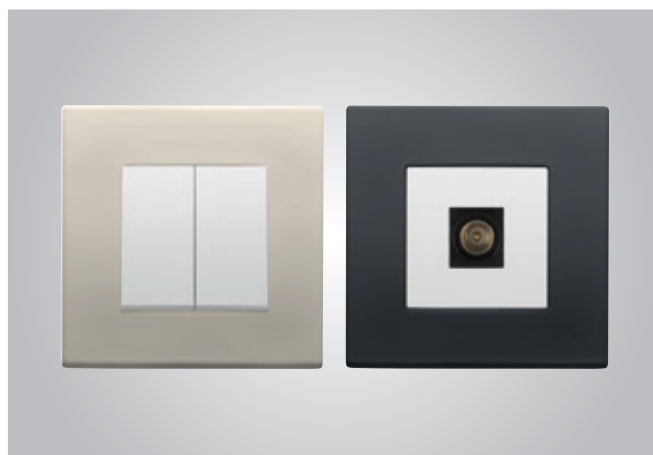

Expandable with Chorus

The special frame support allows the integration of the Dahlia range with the Chorus modular devices, picking up whatever Chorus device you should need. The support has to be completed with Dahlia plates.



DAHLIA PLATES

Tecnopolymer

WHITE



GW 35 901 AW	1 gang
GW 35 902 AW	2 gang
GW 35 903 AW	3 gang
GW 35 904 AW	4 gang
GW 35 905 AW	5 gang
GW 35 909 AW	double

IVORY



GW 35 901 AY	1 gang
GW 35 902 AY	2 gang
GW 35 903 AY	3 gang
GW 35 904 AY	4 gang
GW 35 905 AY	5 gang
GW 35 909 AY	double

HEMP

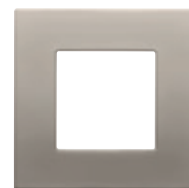

GW 35 901 AH	1 gang
GW 35 902 AH	2 gang
GW 35 903 AH	3 gang
GW 35 904 AH	4 gang
GW 35 905 AH	5 gang
GW 35 909 AH	double

CREAM



GW 35 901 AM	1 gang
GW 35 902 AM	2 gang
GW 35 903 AM	3 gang
GW 35 904 AM	4 gang
GW 35 905 AM	5 gang
GW 35 909 AM	double

LIGHT GREY



GW 35 901 AG	1 gang
GW 35 902 AG	2 gang
GW 35 903 AG	3 gang
GW 35 904 AG	4 gang
GW 35 905 AG	5 gang
GW 35 909 AG	double

DARK GREY



GW 35 901 AD	1 gang
GW 35 902 AD	2 gang
GW 35 903 AD	3 gang
GW 35 904 AD	4 gang
GW 35 905 AD	5 gang
GW 35 909 AD	double

ANTHRACITE GREY



GW 35 901 AN	1 gang
GW 35 902 AN	2 gang
GW 35 903 AN	3 gang
GW 35 904 AN	4 gang
GW 35 905 AN	5 gang
GW 35 909 AN	double

Modularity

Center distance 71 mm

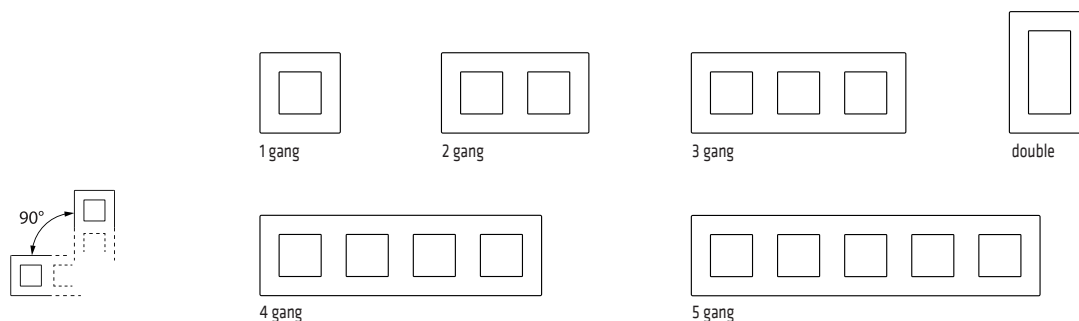

SWITCHES

One-way switches quick wiring					
	GW 35 031 W GW 35 001 Y 1P-10 AX Illuminable (*)	GW 35 002 W GW 35 002 Y 1P-10 AX Backlit	GW 35 006 W GW 35 006 Y 1P-10 AX Backlit	GW 35 003 W GW 35 003 Y 2P-10 AX Illuminable (*)	GW 35 051 W GW 35 051 Y 1P-10 AX Double one-way switch
Two-way switches quick wiring					Intermediate switch quick wiring
	GW 35 071 W GW 35 011 Y 1P-10 AX Illuminable (*)	GW 35 012 W GW 35 012 Y 1P-10 AX Backlit	GW 35 016 W GW 35 016 Y 1P-10 AX Backlit	GW 35 052 W GW 35 052 Y 1P-10 AX Double two-way switch	
Push-buttons quick wiring					
	GW 35 021 W GW 35 021 Y 1P-10 A Illuminable (*)	GW 35 022 W GW 35 022 Y 1P-10 A Backlit	GW 35 026 W GW 35 026 Y 1P-10 A Backlit		

ENERGY SOCKETS

German socket-outlet quick wiring		German socket-outlets screw wiring			
	GW 35 206 W GW 35 201 Y 2P+E-16 A-250 V ac Illuminable (*)		GW 35 207 W GW 35 202 Y 2P+E-16 A-250 V ac Illuminable (*)	GW 35 203 W GW 35 203 Y 2P+E-16 A-250 V ac IP40 - With lid Illuminable (*)	GW 35 204 W GW 35 204 Y 2P+E-16 A-250 V ac Double
French socket-outlet quick wiring		French socket-outlets screw wiring			
	GW 35 216 W GW 35 211 Y 2P+E-16 A-250 V ac Illuminable (*)		GW 35 212 W GW 35 212 Y 2P+E-16 A-250 V ac Illuminable (*)	GW 35 213 W GW 35 213 Y 2P+E-16 A-250 V ac IP40 - With lid Illuminable (*)	GW 35 214 W GW 35 214 Y 2P+E-16 A-250 V ac Double

DIMMERS

Universal dimmer	
	GW 35 301 W GW 35 301 Y 4-160 W With two-way switch 230 V ac-50 Hz

(*) supplied without LED signalling unit

Ⓛ Available from September 2018

DATA SOCKETS

TV socket



GW 35 261 W
GW 35 261 Y
Direct - 0 dB

Telephone socket

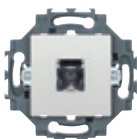

GW 35 251 W
GW 35 251 Y
RJ11

Data sockets

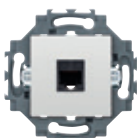

GW 35 271 W
GW 35 271 Y
RJ45 cat.5e
UTP

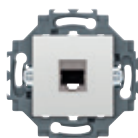

GW 35 272 W
GW 35 272 Y
RJ45 cat.5e
FTP

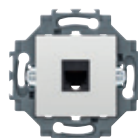

GW 35 273 W
GW 35 273 Y
RJ45 cat.6
UTP



GW 35 274 W
GW 35 274 Y
RJ45 cat.6
FTP

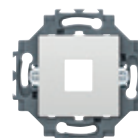

GW 35 280 W
GW 35 280 Y
Empty enclosure

USB and HDMI couplers



GW 38 056
HDMI coupler



GW 38 057
USB coupler

ACCESSORIES

LED signalling unit



GW 35 981
230 V ac-50/60 Hz

Lens with illuminated symbol



GW 35 986
Lens kit

Protective cover



GW 35 996
For painting

Wall-mounting boxes - IP40



GW 35 911
1 gang



GW 35 912
2 gang

SUPPORTS FOR MODULAR DEVICES

Support

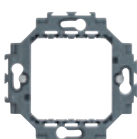



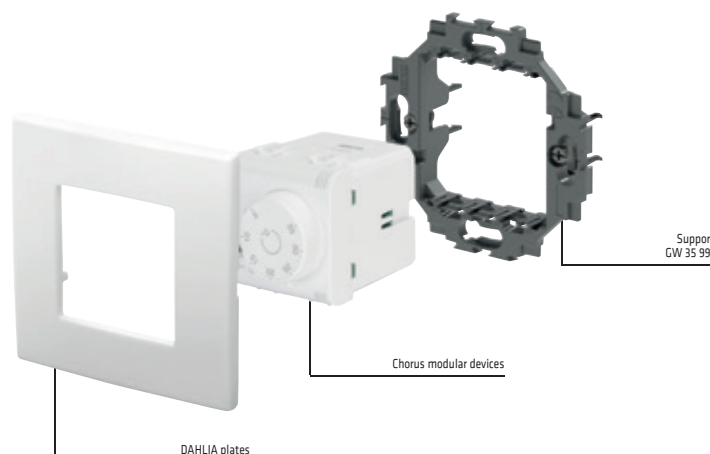

GW 35 991

All Chorus modular devices (max. 2 modules) can be fitted with GW35991 supports and completed with DAHLIA plates.

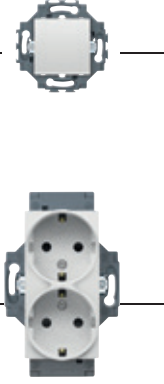

Dahlia devices are suitable for Ø 60 mm round boxes. They can be used with all the Gewiss round boxes. They can be mounted on the Gewiss GW 24 231 square boxes only with screws (not with clutches).

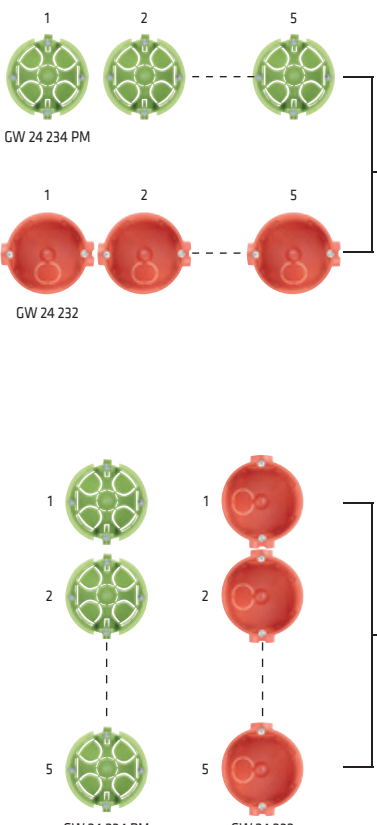
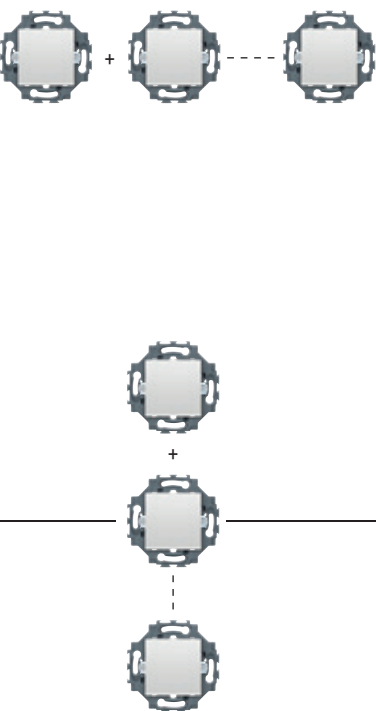
Dahlia PLATES AND DEVICES

BOXES (*)	DEVICES	PLATES
 <p>GW 24 234 PM</p> <p>GW 24 232</p> <p>GW 24 208</p> <p>GW 24 209</p>		 <p>1 gang</p> <p>double</p>
 <p>1 GW 24 234 PM</p> <p>2 GW 24 232</p> <p>1 GW 24 234 PM</p> <p>2 GW 24 232</p> <p>1 GW 24 234 PM</p> <p>2 GW 24 232</p>		 <p>2 gang</p> <p>3 gang</p> <p>4 gang</p> <p>5 gang</p>

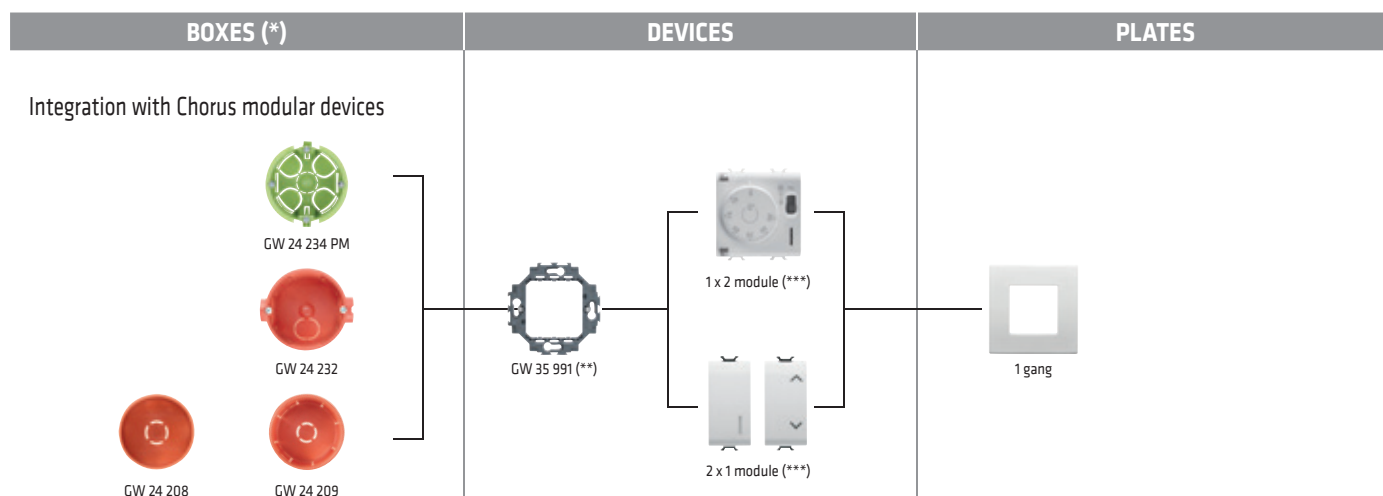

(*) GW 24 231 Flush-mounting square boxes can be used only with screws (not with clutches)

(**) The support GW 35 991 can be used individually or in array configuration, also in combination with the monobloc devices

(***) From Chorus modular devices range

Wireless Devices

ZIGBEE®



Home Automation

KNX EASY BUS



page 66

Building Automation

KNX BUS



page 70

The new range of wireless Zigbee devices for command and control offers innovative solutions for the renovation of buildings, minimising the structural interventions.

Easy renovations

Elimination of device cabling allows you to save money and introduce Home&Building Automation functions also where masonry works are not possible, in particular during renovations.



Safe and reliable technology

Zigbee® is a secure system, because the data exchanged between devices are encrypted and reliable because every node in the network retransmits the information to always guarantee the reachability of all the devices (mesh network).

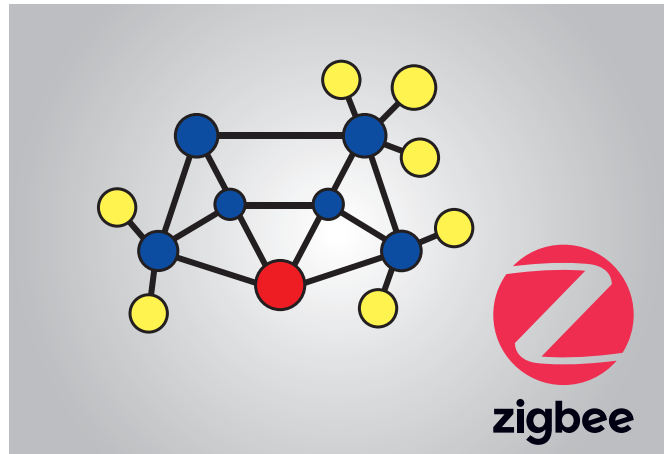

Integration with Home & Building automation

The Zigbee® devices can be controlled by the App, locally or in remote by means smartphone and tablet, and integrated in the Gewiss Home&Building Automation thanks to the Smart Gateway that makes it possible to realize also advanced functions.



SYSTEM COMPONENTS

Complementary items



GW A1 706
USB/Zigbee Interface

COMMAND DEVICES

Contacts interfaces



GW A1 501
2-channel potential-free
Battery powered



GW A1 502
2-channel
230Vac - 50Hz

ACTUATORS

General loads actuators



GW A1 521
1-channel 10A potential-free



GW A1 522
2-channel 6A
230Vac - 50Hz

Roller shutter actuator



GW A1 531
1-channel 6A
230Vac - 50Hz

LOAD MANAGEMENT

Load management relay



GW A1 916
P-Comfort
230Vac - 50Hz

General loads actuator with power meter



GW A1 523
1-channel 10A with power meter
230Vac - 50Hz

Smart plug



GW A1 526
10A Schuko adapter with power meter
230Vac

Load management kit



GW A1 911
P-Comfort + 1 Smart plug



GW A1 912
P-Comfort + 2 Smart plugs

SENSORS AND ALARMS

Sensors



GW A1 511
Motion sensor
Battery powered



GW A1 513
Door/window sensor
Battery powered

Alarms



GW A1 514
Flood alarm
Battery powered



GW A1 512
Smoke alarm
Battery powered

SYSTEM SUPERVISION

Gateway



GW A9 000
Smart gateway
12Vdc - 1A

ACCESSORIES

Chorus blanking modules



GW 10 750 White
GW 12 750 Black
GW 14 750 Titanium

For housing contact
interfaces and actuators

Home Automation **KNX EASY BUS**

The CHORUS HOME AUTOMATION range offers the KNX Easy BUS system - an advanced control system which, in accordance with European Standard EN50090 for Home Automation, enables each system component to converse with the others.

The system that interacts with the home

Gewiss' Home Automation range is a complete, versatile selection of products that allows you to create a complete and advanced system for apartments or villas which is able to satisfy each application need. The functions of the home can be managed and supervised locally or remotely via an internet connection (cloud-platform based) thanks to the Smart Gateway and the relative app for smartphone and tablet.



The KNX Easy system

Security, safety, comfort, energy savings, scenes, integration with other technologies and remote control: the Easy devices make the home smart, and every choice becomes simple and more environmentally friendly. Technology meets Italian style.



Easy controller

The KNX Easy devices can be configured and programmed with ETS sw (S-mode) or alternatively in a simplified way, through the Easy controller sw (E-mode) by means of a PC and a KNX BUS access interface (generally a KNX/USB interface). The software automatically detects all the Easy devices located on the BUS and helps you create functions between commands/sensors and actuators, even in Off-Line mode.



SYSTEM COMPONENTS

Self-protected electronic power supplies



GW 90 709
320 mA
220-240 V ac - 50/60 Hz



GW 90 710
640 mA
220-240 V ac - 50/60 Hz

Complementary items



GW 90 708 A
Line/Field coupling



GW 90 706 B
KNX/USB interface



GW 90 706 S
KNX/USB stick interface



GW A9 705
KNX/IP interface

SYSTEM SUPERVISION

Gateway



GW A9 000
Smart gateway
12Vdc - 1A

COMMAND DEVICES

TOUCH push-button panel module with interchangeable symbols



GW A9 471
EASY 6-channels
with interchangeable symbols

ICE TOUCH KNX glass plates



GW 16 946 CB
White
GW 16 946 CN
Black
GW 16 946 CT
Titanium

TOUCH push-button panel module



GW 10 741
EASY 6-channels

ICE TOUCH KNX glass plates

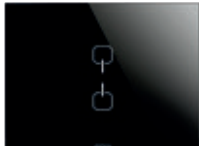

2 symbols



4 symbols



6 symbols

GW 16 966 CB
White
GW 16 966 CN
Black
GW 16 966 CT
Titanium

Contacts interfaces



GW 90 833
EASY 2-channel



GW 90 834 A
EASY 4-channel

LED signalling unit



GW 10 886 Blue 3.3 V dc
GW 10 887 White 3.3 V dc
GW 10 888 Red 3.3 V dc
GW 10 889 Green 3.3 V dc
GW 10 890 Amber 3.3 V dc

Blanking modules



For housing contacts interfaces

GW 10 751
White
GW 12 751
Black
GW 14 751
Titanium

Electronic push-buttons



Universal
1M-1P-NO

GW 12 915
Black

GW 14 915
Titanium



For BUS inputs
1M-1P-NO Backlit

GW 12 913
Black

GW 14 913
Titanium



For BUS inputs
1M-1P-NO Backlit

GW 12 916
Black

GW 14 916
Titanium



For BUS inputs
2M-1P-NO Backlit

GW 12 917
Black

GW 14 917
Titanium



For BUS inputs
2M-1P-NO Backlit

GW 12 918
Black

GW 14 918
Titanium

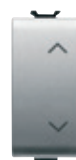

With interlock
1M-1P-NO+NO

GW 12 914
Black

GW 14 914
Titanium

COMMAND DEVICES

Push-button panels



GW 10 753 A White
GW 12 753 A Black
GW 14 753 A Titanium

EASY 6-channel with interchangeable symbols



GW 10 754 A White
GW 12 754 A Black
GW 14 754 A Titanium

EASY 6-channel + actuator with interchangeable symbols



GW 10 755 A White
GW 12 755 A Black
GW 14 755 A Titanium

EASY 6-channel + roller shutter actuator with interchangeable symbols



GW 10 757 White
GW 12 757 Black
GW 14 757 Titanium

EASY 4-channel with interchangeable symbols



GW 10 752 White
GW 12 752 Black
GW 14 752 Titanium

EASY 4-channel

Interchangeable button keys for push-button panels



GW 10 551 White
GW 12 551 Black
GW 14 551 Titanium

1M button key
To be completed with lens



GW 10 552 White
GW 12 552 Black
GW 14 552 Titanium

2M button key
To be completed with lens



GW 10 553 White
GW 12 553 Black
GW 14 553 Titanium

1M button key
To be completed with 2 lenses



GW 10 554 White
GW 12 554 Black
GW 14 554 Titanium

2M button key
To be completed with 2 lenses



GW 10 557 White
GW 12 557 Black
GW 14 557 Titanium



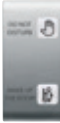







































1M button key
With 2 diffusers



GW 10 559 White
GW 12 559 Black
GW 14 559 Titanium

1M button key
Complete with 2 lenses
DND+MUR

Lens with illuminated symbols

										
GW 10 501 A Transparent	GW 10 502 A Light	GW 10 503 A Stair light	GW 10 504 A Table light	GW 10 505 A Bell	GW 10 506 A Burglar alarm	GW 10 507 A Key	GW 10 508 A ON OFF	GW 10 509 A ON	GW 10 510 A OFF	GW 10 511 A Socket
										
GW 10 512 A Dimmer	GW 10 513 A Dimmer increase	GW 10 514 A Dimmer decrease	GW 10 515 A Arrow	GW 10 516 A Open	GW 10 517 A Close	GW 10 518 A Roller shutter	GW 10 519 A Roller shutter up	GW 10 520 A Roller shutter down	GW 10 521 A Curtain open	GW 10 522 A Curtain close
										
GW 10 523 A Floor light	GW 10 524 A Ceiling light	GW 10 525 A Wall light	GW 10 526 A Aisle light	GW 10 527 A Scenario	GW 10 528 A Party	GW 10 529 A In	GW 10 530 A Out	GW 10 531 A Good morning	GW 10 532 A Good night	GW 10 533 A TV
										
GW 10 534 A Heating	GW 10 535 A Cooling	GW 10 536 A Heating/Cooling	GW 10 537 A Comfort	GW 10 538 A Precomfort	GW 10 539 A Economy	GW 10 540 A Auto	GW 10 541 A Do not disturb	GW 10 542 A Make up the room		

SENSORS

Movement



GW 10 756 White
GW 12 756 Black
GW 14 756 Titanium

EASY IR movement detectors with twilight sensor

Weather















GW 90 769
Wind sensor













GW 90 770
Wind sensor interface
230 V ac - 50/60 Hz







ACTUATORS

General loads actuators		GW 10 766 White GW 12 766 Black GW 14 766 Titanium		GW 90 835 B EASY 4-channel 10 A 4 NO 230 V ac - 50/60 Hz		GW 90 836 B EASY 4-channel 16 AX 4 NO 230 V ac - 50/60 Hz	Roller shutter actuators		GW 10 767 White GW 12 767 Black GW 14 767 Titanium		GW 90 851 EASY 2-channel 6 A 230 V ac - 50/60 Hz		GW 90 852 EASY 4-channel 6 A 230 V ac - 50/60 Hz
	Dimmer actuators		GW A9 351 Universal EASY 1-channel 500 VA - 230V ac - 50/60 Hz		GW A9 352 Universal EASY 2-channel 300 VA - 230V ac - 50/60 Hz			GW A9 350 Bleeder 230V ac - 50 Hz		GW 90 854 For CVD LED EASY 4-channel 12-24 V dc		GW 90 855 For CVD LED EASY 4-channel 12-48 V dc	





TEMPERATURE ADJUSTMENT

Climate control		GW 10 764 H White GW 12 764 H Black GW 14 764 H Titanium	EASY timed thermostats/ programmers with humidity management (*)		GW 10 765 H White GW 12 765 H Black GW 14 765 H Titanium	EASY thermostats with humidity management (*)		GW 10 769 White GW 12 769 Black GW 14 769 Titanium	EASY temperature/ humidity sensors		GW 10 769 H White GW 12 769 H Black GW 14 769 H Titanium	EASY temperature/ humidity sensors		GW 10 762 H White GW 12 762 H Black GW 14 762 H Titanium	KNX/Easy temperature/ humidity probe sensors		GW 10 800 External temperature probe sensor
		GW 10 900 White GW 12 900 Black GW 14 900 Titanium	Temperature probe sensors		GW 16 974 CB White GW 16 974 CN Black GW 16 974 CT Titanium	KNX/Easy Thermo ICE thermostats 12-24 V ac/dc		GW 10 720 Power supply 100/240 V ac-50/60 Hz-12 V dc		GW 10 761 White GW 14 761 Titanium	Wall-mounting EASY timed thermostats		GW 10 763 White GW 14 763 Titanium	Wall-mounting EASY thermostats			

ENERGY CONTROL

Energy meters		GW D6 801 Single-phase direct connection		GW D6 806 Three-phase direct connection		GW D6 807 Three-phase direct connection MID	Interface		GW D6 808 Three-phase amperometric transformer connection		GW D6 809 Three-phase C.T. connection MID		GW 90 876 KNX interface for energy meter
----------------------	---	--	---	---	---	---	------------------	--	--	---	---	---	---

COMPLEMENTARY ITEMS

Accessories		GW 90 807 Connection terminal to BUS		GW 90 808 Connection terminal to SELV line		GW 90 583 BUS KNX cable 2 conductors 1x2x0,8		GW 90 582 BUS KNX cable 4 conductors 2x2x0,8
--------------------	---	---	---	---	---	--	---	--

(*) Not provided with built-in humidity sensor

Building Automation **KNX BUS**

The CHORUS BUILDING AUTOMATION range offers the ideal solution for both homes and large buildings, without limiting the number of devices that can be connected or the size of the system.

Standard communication protocol

KNX is the European Standard for transmitting and managing data in building automation. The KNX BUS is an open solution, and as such offers a significant guarantee of interoperability (i.e. compatibility between KNX products made by different manufacturers). The KNX Standard complies with the European Standard EN50090 and the world Standard ISO/IEC14543.



Modification adaptability and flexibility

The KNX BUS devices are programmed with ETS (EIB Tool Software), a special software that allows you to create the logic connections necessary in order to produce the required functions. With simple software modification, it's possible at any time to assign different functions to the various devices installed without having to modify the product wiring.



System supervision

The new Smart Gateway, with its control and supervision App, represents the ideal solution in the Home&Building Automation to manage the functions of the system based on the cloud platform thus making it possible the integration with the IoT (Internet of Things) applications.



SYSTEM COMPONENTS

Self-protected electronic power supplies

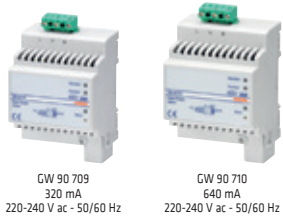

GW 90 709
320 mA
220-240 V ac - 50/60 Hz

GW 90 710
640 mA
220-240 V ac - 50/60 Hz

Complementary items

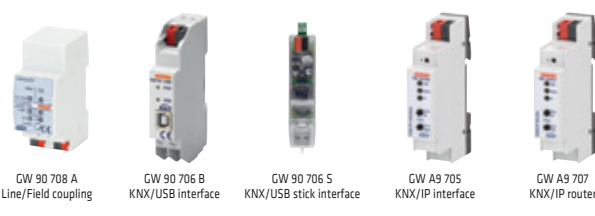

GW 90 708 A
Line/Field coupling

GW 90 706 B
KNX/USB interface

GW 90 706 S
KNX/USB stick interface

GW A9 705
KNX/IP interface

GW A9 707
KNX/IP router

SYSTEM SUPERVISION

Gateway



GW A9 000
Smart gateway
12Vdc - 1A

MASTER ICE touch-screen panels



GW 12 010 CB
10" White
GW 12 010 CN
10" Black



Power supply 24 V dc-2.5 A
100-240 V ac-50/60 Hz

COMMAND DEVICES

TOUCH push-button panel module with interchangeable symbols



GW A9 421
KNX 6-channels
with interchangeable symbols

ICE TOUCH KNX glass plates



GW 16 946 CB
White
GW 16 946 CN
Black
GW 16 946 CT
Titanium

TOUCH push-button panel module



GW 10 746
KNX 6-channels

ICE TOUCH KNX glass plates



2 symbols

GW 16 962 CB
White
GW 16 962 CN
Black
GW 16 962 CT
Titanium



4 symbols

GW 16 964 CB
White
GW 16 964 CN
Black
GW 16 964 CT
Titanium



6 symbols

GW 16 966 CB
White
GW 16 966 CN
Black
GW 16 966 CT
Titanium

Contacts interfaces



GW 90 727
KNX 2-channel



GW 90 721 A
KNX 4-channel



GW 90 728
KNX 8-channel input module
(4 digital + 4 universal)



GW 90 729
KNX 8-channel ac/dc
voltage input module

LED signalling unit



GW 10 886 Blue 3.3 V dc
GW 10 887 White 3.3 V dc
GW 10 888 Red 3.3 V dc
GW 10 889 Green 3.3 V dc
GW 10 890 Amber 3.3 V dc

Blanking modules

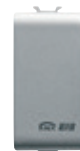

For housing contacts interfaces

GW 10 751
White
GW 12 751
Black
GW 14 751
Titanium

Electronic push-buttons



Universal
1M-IP-NO

GW 10 915
White
GW 12 915
Black
GW 14 915
Titanium



For BUS inputs
1M-IP-NO Backlit

GW 10 913
White
GW 12 913
Black
GW 14 913
Titanium



For BUS inputs
1M-IP-NO Backlit

GW 10 916
White
GW 12 916
Black
GW 14 916
Titanium



For BUS inputs
2M-IP-NO Backlit

GW 10 917
White
GW 12 917
Black
GW 14 917
Titanium



For BUS inputs
2M-IP-NO Backlit

GW 10 918
White
GW 12 918
Black
GW 14 918
Titanium

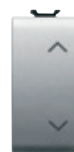

With interlock
1M-IP-NO-NO

GW 10 914
White
GW 12 914
Black
GW 14 914
Titanium

COMMAND DEVICES

Push-button panels



GW 10 783 A White
GW 12 783 A Black
GW 14 783 A Titanium

KNX 6-channel with interchangeable symbols



GW 10 784 A White
GW 12 784 A Black
GW 14 784 A Titanium

KNX 6-channel + actuator with interchangeable symbols



GW 10 785 A White
GW 12 785 A Black
GW 14 785 A Titanium

KNX 6-channel + roller shutter actuator with interchangeable symbols



GW 10 787 White
GW 12 787 Black
GW 14 787 Titanium

4-channel KNX with interchangeable symbols



GW 10 782 White
GW 12 782 Black
GW 14 782 Titanium

KNX 4-channel

Interchangeable button keys for push-button panels



GW 10 551 White
GW 12 551 Black
GW 14 551 Titanium

1M button key
To be completed with lens



GW 10 552 White
GW 12 552 Black
GW 14 552 Titanium

2M button key
To be completed with lens



GW 10 553 White
GW 12 553 Black
GW 14 553 Titanium

1M button key
To be completed with 2 lenses



GW 10 554 White
GW 12 554 Black
GW 14 554 Titanium

2M button key
To be completed with 2 lenses



GW 10 557 White
GW 12 557 Black
GW 14 557 Titanium











































1M button key
With 2 diffusers



GW 10 559 White
GW 12 559 Black
GW 14 559 Titanium

1M button key
Complete with 2 lenses DND+MUR

Lens with illuminated symbols

 GW 10 501 A Transparent	 GW 10 502 A Light	 GW 10 503 A Stair light	 GW 10 504 A Table light	 GW 10 505 A Bell	 GW 10 506 A Burglar alarm	 GW 10 507 A Key	 GW 10 508 A ON OFF	 GW 10 509 A ON	 GW 10 510 A OFF	 GW 10 511 A Socket
 GW 10 512 A Dimmer	 GW 10 513 A Dimmer increase	 GW 10 514 A Dimmer decrease	 GW 10 515 A Arrow	 GW 10 516 A Open	 GW 10 517 A Close	 GW 10 518 A Roller shutter	 GW 10 519 A Roller shutter up	 GW 10 520 A Roller shutter down	 GW 10 521 A Curtain open	 GW 10 522 A Curtain close
 GW 10 523 A Floor light	 GW 10 524 A Ceiling light	 GW 10 525 A Wall light	 GW 10 526 A Aisle light	 GW 10 527 A Scenario	 GW 10 528 A Party	 GW 10 529 A In	 GW 10 530 A Out	 GW 10 531 A Good morning	 GW 10 532 A Good night	 GW 10 533 A TV
 GW 10 534 A Heating	 GW 10 535 A Cooling	 GW 10 536 A Heating/Cooling	 GW 10 537 A Comfort	 GW 10 538 A Precomfort	 GW 10 539 A Economy	 GW 10 540 A Auto	 GW 10 541 A Do not disturb	 GW 10 542 A Make up the room		

SENSORS

Movement



GW 10 786 White
GW 12 786 Black
GW 14 786 Titanium

KNX IR movement detector with twilight sensor



GW 90 787

KNX outdoor movement detector with twilight sensor



GW 90 782

Mounting bracket for KNX outdoor movement detector



GW A9 531

KNX presence sensor ceiling mounting



GW A9 532

KNX movement sensor with constant brightness control ceiling mounting for great heights



GW A9 540

IR remote control



GW A9 541

Assembly accessory IP54



GW A9 542

IP65 Kit

WEATHER SENSORS

Devices



GW 90 800
KNX weather station



GW 90 881
KNX rain sensor



GW 90 882
KNX wind sensor



GW 90 883
KNX wind and rain sensor



GW 90 884
KNX light intensity sensor



GW 90 885
KNX temperature sensor

ACTUATORS

General loads actuators



KNX 1-channel 16 A
1 NO/NC 230 V ac - 50/60 Hz

GW 10 796
White
GW 12 796
Black
GW 14 796
Titanium



GW 90 741
KNX 4-channel 10 A
4 NO 230 V ac - 50/60 Hz



GW 90 740 A
KNX 4-channel 16 AX
4 NO 230 V ac - 50/60 Hz



GW 90 742
KNX 4-channel 16 AX with manual command
4 NO 230 V ac - 50/60 Hz



GW A9 108
KNX 8-channel 10 AX
8 NO 230 V ac - 50/60 Hz

Roller shutter actuators



KNX 1-channel 6 A
230 V ac - 50/60 Hz

GW 10 797
White
GW 12 797
Black
GW 14 797
Titanium



GW 90 856
KNX 2-channel 6 A
230 V ac - 50/60 Hz



GW 90 857
KNX 4-channel 6 A
230 V ac - 50/60 Hz

Combined actuators



GW 90 730
KNX 4-channel actuator 10 A
+ 4 universal inputs



GW A9 126
KNX 6/12-channels 8 AX for shutters/
generic loads 12 NO 230 V ac - 50/60 Hz

Dimmer actuators



GW A9 313
for electronic ballast 1-10V
3 channels 16 AX KNX
230 V ac - 50/60 Hz



GW A9 301
Universal
KNX 1-channel
500 VA - 230V ac - 50/60 Hz



GW A9 302
Universal
KNX 2-channel
300 VA - 230V ac - 50/60 Hz



GW A9 350
Bleeder 230V ac - 50 Hz



GW 90 764
For CVD LED
KNX 4-channel
12-24 V dc













GW 90 765
For CCD LED
KNX 4-channel
12-48 V dc









GW 90 766
Booster for CVD LED
dimmer 4x10A 12-24 V dc

TEMPERATURE ADJUSTMENT

Climate control		<p>CW 10 794 H White</p> <p>CW 12 794 H Black</p> <p>CW 14 794 H Titanium</p>		<p>CW 10 795 H White</p> <p>CW 12 795 H Black</p> <p>CW 14 795 H Titanium</p>		<p>GW 10 799 White</p> <p>GW 12 799 Black</p> <p>GW 14 799 Titanium</p>		<p>GW 10 799 H White</p> <p>GW 12 799 H Black</p> <p>GW 14 799 H Titanium</p>		<p>GW 10 762 H White</p> <p>GW 12 762 H Black</p> <p>GW 14 762 H Titanium</p>		<p>GW 10 800 External temperature probe sensor</p>
		<p>GW 10 900 White</p> <p>GW 12 900 Black</p> <p>GW 14 900 Titanium</p>		<p>GW 16 974 CB White</p> <p>GW 16 974 CN Black</p> <p>GW 16 974 CT Titanium</p>		<p>GW 10 720 Power supply 100/240 V ac-50/60 Hz-12 V dc</p>		<p>GW 10 791 White</p> <p>GW 14 791 Titanium</p>		<p>GW 10 793 White</p> <p>GW 14 793 Titanium</p>		

ENERGY CONTROL

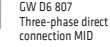



Energy meters		<p>CW D6 801 Single-phase direct connection</p>		<p>CW D6 806 Three-phase direct connection</p>		<p>GW D6 808 Three-phase C.T. connection</p>	Interface		<p>GW D6 809 Three-phase C.T. connection MID</p>		<p>GW 90 876 KNX interface for energy meter</p>
		<p>CW D6 802 Single-phase direct connection MID</p>		<p>CW D6 807 Three-phase direct connection MID</p>							

FUNCTION DEVICE

Logic module		<p>GW 90 797 A KNX logic module</p>
---------------------	---	---





(*) Not provided with built-in humidity sensor

ACCESS CONTROL AND HOTEL MANAGEMENT

Transponder units		GW 10 681 White GW 12 681 Black GW 14 681 Titanium		GW 10 682 White GW 12 682 Black GW 14 682 Titanium		GW 10 683 White GW 12 683 Black GW 14 683 Titanium	
	KNX transponder card reader unit 12/24 V ac/dc		KNX transponder card holder unit 12/24 V ac/dc		Transponder card programming unit. Powered via USB		GW 10 684 Transponder card

Software		GW A9 781 Up to 10 rooms GW A9 782 Up to 25 rooms GW A9 783 Up to 100 rooms GW A9 784 Over 100 rooms
	Hotel management software GWHost	

COMPLEMENTARY ITEMS

Interfaces		Accessories			
	GW 90 871 Gateway KNX/DMX		GW 90 872 A Gateway KNX/DALI 64/16	GW 90 807 Connection terminal to BUS	

Flush-mounting boards

Domo Center

FLUSH-MOUNTING SYSTEM COLUMNS FOR DISTRIBUTION, H&B AUTOMATION AND DATA





Domo Center FLUSH-MOUNTING SYSTEM COLUMNS FOR DISTRIBUTION, DOMOTICS AND DATA

A solution in harmony with the surroundings

DOMO CENTER is the system column designed by Gewiss for residential and commercial use.

This solution transforms the domestic system into a furnishing accessory, with its modern design that adapts to suit the context. It centralises and rationalises the existing services, from the most traditional to the most advanced, in one single device.

The Domo Center range is divided into 2 parts:

- **Front configuration kit** • already configured with all the necessary items for setting up the system column (with the exception of the back-mounting box)
- **Components** • the single elements needed to create any type of KIT



- **Flush-mounting back-mounting box, 2700 or 2400mm high**
- **External dimensions 2400 and 2100mm**
- **Protrusion of only 25mm from the wall, with suspended effect**
- **Modular capacity of up to 320 modules**
- **Versions already configured (kits) in different types**



reddot design award
winner 2016

Applications



Domo Center with exposed functional panels



Domo Center integrated with the furniture style



Domo Center with integral transparent door

HOW TO REQUEST THE MOST SUITABLE CONFIGURATION (KIT)

Contact Customer Service (sat@gewiss.com) or the sales organisation for cost estimates and support for configuring your system. The request procedure is facilitated by the Gweb DOMO CENTER software, available free of charge at gewiss.com.



Available finishes

DOMO CENTER can be configured in numerous solutions, with or without doors.

In fact, personalised configurations can be created by simply combining the system column with the Domo Center components. The version with door is available in three different materials: smoked transparent glass, full mirror or metal.



e.g. version 2700 with door



reddot design award
winner 2016



e.g. version 2400 without door

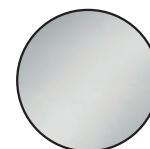

Mirror

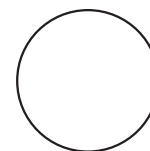

White RAL 9003



Maple

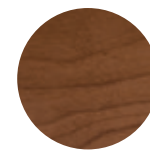

Cherry



Moon



Lava

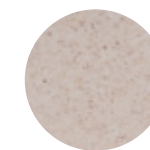

Sand

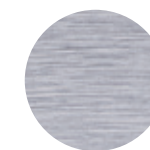

Brushed White

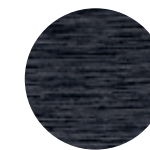

Brushed Grey

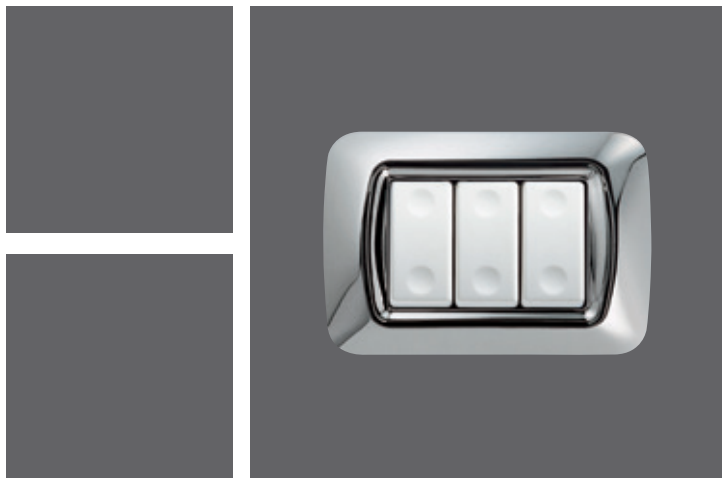

GEWISS

Visit www.gewiss.com and follow us on:

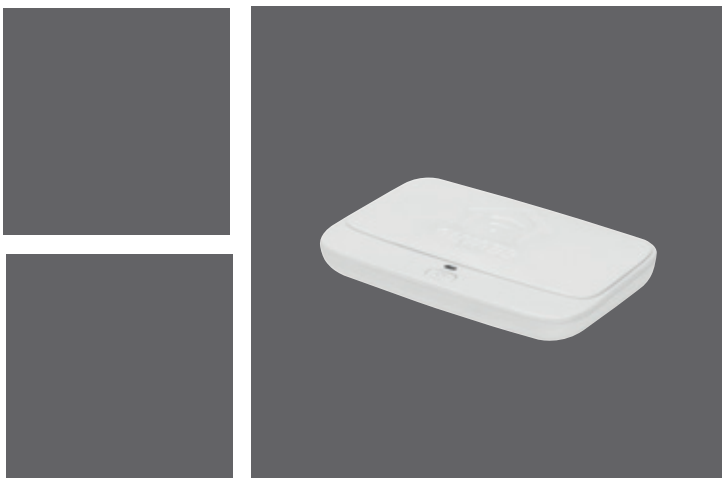

GEWISS S.p.A.

GEWISS S.p.A. Registered office
Via A. Volta, 1 - 24069 CENATE SOTTO (Bergamo) - Italy
Tel. +39 035 946 111 - Fax +39 035 945 222
gewiss@gewiss.com - www.gewiss.com

Sole Shareholder company - Bergamo Register of Companies/ VAT / Tax code (IT) 00385040167
REA 107496 - Share Capital 60,000,000.00 EUR fully paid up